



BMW Motorrad

Rider's manual

R 1250 RT special vehicle

Vehicle data/dealership details

Vehicle data

Model

Vehicle Identification Number

Colour code

Date of first registration

Registration number

Dealership details

Person to contact in Service department

Ms/Mr

Phone number

Dealership address/phone number (company stamp)

Welcome to BMW

We congratulate you on your choice of a vehicle from BMW Motorrad and welcome you to the community of BMW riders. Familiarise yourself with your new vehicle so that you can ride it safely and confidently in all traffic situations.

About this Rider's Manual

Please read this Rider's Manual carefully before starting to use your new BMW. It contains important information on how to operate the controls and how to make the best possible use of all your BMW's technical features. In addition, it contains information on maintenance and care to help you maintain your vehicle's reliability and safety, as well as its value.

This record of the maintenance work you have had performed on

your vehicle is a precondition for generous treatment of goodwill claims.

If the time comes to sell your BMW, please remember to hand over this Rider's Manual to the new owner. It is an important part of the vehicle.

Suggestions and criticism

If you have questions concerning your vehicle, your authorised BMW Motorrad dealer will gladly provide advice and assistance.

We hope you will enjoy riding your BMW and that all your journeys will be pleasant and safe

BMW Motorrad.

01 40 9 443 691



Table of Contents

1 General instructions	5	3 Status indicators	25	Turn indicators	69
Overview	6	Indicator and warning		Light signals.....	69
Abbreviations and		lights	26	Sound signals	75
symbols	6	Meaning of symbols.....	27	Multifunction display	78
Equipment	7	Multifunction display	29	On-board computer	82
Technical data	7	Warnings	30	Authorities speed indic-	
Currentness	8	Service-due indicator.....	49	ator.....	83
Additional sources of informa-		Range	50	Trip recorder	84
tion.....	8	Electronic oil-level check	50	Antilock Brake System	
Certificates and operating li-		Ambient temperature.....	51	(ABS).....	85
cences	8	Tyre pressures	51	Automatic Stability Control	
Data memory.....	8	Authorities speed indic-		(ASC)	85
		ator.....	52	Dynamic Traction Control	
2 General views	13	4 Operation.....	53	(DTC)	86
General view, left side	15	Ignition switch/steering		Electronic Suspension Ad-	
General view, right side	17	lock	54	justment (D-ESA)	87
Underneath the seat	18	Ignition with Key-		Riding mode	88
Multifunction switch, left	19	less Ride	56	Cruise-control system.....	89
Multifunction switch,		Emergency off switch (kill		Hill Start Control	91
right	21	switch)	62	Anti-theft alarm (DWA)	94
Instrument panel	23	Lights	63	Heating.....	98
		Day run lights	66	Front seat	100
		Hazard warning lights sys-		Rear seat.....	101
		tem	68	Adjusting spray guard	102

Stowage compartment	103	Securing motorcycle for transportation	133	Engine oil	154
Central locking system	103	7 Engineering details	135	Brake system	155
5 Adjustment	109	General instructions	136	Clutch	160
Mirrors	110	Antilock Brake System (ABS)	136	Coolant	160
Headlight	110	Automatic Stability Control (ASC)	139	Tyres	162
Windscreen	110	Dynamic Traction Control (DTC)	141	Rims and tyres	162
Instrument panel	111	Electronic Suspension Adjustment (D-ESA)	142	Wheels	163
Clutch	112	Riding mode	143	Silencer	169
Brakes	112	Dynamic Brake Control ...	145	Lighting	171
Spring preload	113	Tyre pressure control (RDC)	146	Jump-starting	176
Damping	114	Shift assistant	147	Battery	177
6 Riding	117	Hill Start Control	149	Fuses	185
Safety information	118	Engine run-on circuit	150	Diagnostic connector	187
Comply with checklist	120	8 Maintenance	151	9 Accessories	189
Always before riding off ...	120	General instructions	152	General instructions	190
Every 3rd refuelling stop	120	Standard toolkit	152	Power sockets	190
Starting	121	Service toolkit	152	Cases	191
Running in	124	Front-wheel stand	153	Case for special vehicle ...	193
Shifting gear	125			Fire extinguisher	194
Brakes	126			Radio transceiver box	195
Parking your motorcycle	128			Topcase	196
Refuelling	129			Navigation system	199
				Socket for optional accessories	202

10 Care	205	Electrical system	224	13 Appendix.....	255
Care products	206	Anti-theft alarm.....	226	Certificate for electronic immobiliser	256
Washing the vehicle.....	206	Dimensions	226	Certificate for remote key	258
Cleaning easily damaged components.....	207	Weights	227	Certificate for Key-less Ride	262
Care of paintwork	208	Riding specifications	227	Certificate for tyre pressure control (RDC)	264
Vehicle preservation.....	208	Country relevant encoding for sound signals	227		
Laying up the motor-cycle	208	Function key assignment	228	14 Index	265
Restoring motorcycle to use	209	Special functions	229		
11 Technical data	211	12 Service	231		
Troubleshooting chart	212	BMW Motorrad Service ...	232		
Screw connections	213	BMW Motorrad Service history.....	232		
Fuel	215	BMW Motorrad Mobility services	233		
Engine oil	216	Maintenance work.....	233		
Engine	216	BMW Service	233		
Clutch	217	Maintenance schedule	237		
Transmission	218	Maintenance confirmations.....	238		
Rear-wheel drive	219	Service confirmations	252		
Frame	219				
Chassis and suspension	220				
Brakes	221				
Wheels and tyres.....	222				

General instructions

Overview	6
Abbreviations and symbols	6
Equipment	7
Technical data	7
Currentness	8
Additional sources of information	8
Certificates and operating licences	8
Data memory	8

Overview

An important aspect of this Rider's Manual is that it can be used for quick and easy reference. Consulting the extensive index at the end of this Rider's Manual is the fastest way to find information on a particular topic or item. To first read an overview of your motorcycle, please go to Chapter 2. All maintenance and repair work on the motorcycle is documented in Chapter 12. This record of the maintenance work you have had performed on your vehicle is a precondition for generous treatment of goodwill claims. When the time comes to sell your BMW, please remember to hand over this Rider's Manual; it is an important part of the motorcycle.

Abbreviations and symbols



CAUTION Low-risk hazard. Non-avoidance can lead to slight or moderate injury.



WARNING Medium-risk hazard. Non-avoidance can lead to fatal or severe injury.



DANGER High-risk hazard. Non-avoidance leads to fatal or severe injury.





ATTENTION Special notes and precautionary measures. Non-compliance can lead to damage to the vehicle or accessory and, consequently, to voiding of the warranty.



NOTICE Specific instructions on how to operate, control, adjust or look after items of equipment on the vehicle.



Indicates the end of an item of information.

- Instruction.
- » Result of an activity.
- ➔ Reference to a page with more detailed information.
- ◁ Indicates the end of a passage relating to specific accessories or items of equipment.
-  Tightening torque.
-  Technical data.
- NV National-market version.

OE	Optional extras. The vehicles are assembled complete with all the BMW Motorrad optional extras originally ordered.
OA	Optional accessories. You can obtain BMW Motorrad optional accessories through your authorised BMW Motorrad dealer; optional accessories have to be retrofitted to the vehicle.
EWS	Electronic immobiliser.
DWA	Anti-theft alarm (Diebstahlwarnanlage).
ABS	Anti-lock brake system.
ASC	Automatic Stability Control.

D-ESA	Electronic chassis and suspension adjustment.
DTC	Dynamic Traction Control (optional extra only in combination with Pro riding modes).
RDC	Tyre pressure monitoring.

Equipment

When purchasing your BMW motorcycle, you chose a model with individual equipment. This rider's manual describes optional equipment (OE) and selected optional accessories (OA) provided by BMW. Please make allowance for the fact that some equipment specifications may be described that you have not selected. Equally, country-specific deviations to the motorcycle shown are also possible.

If your motorcycle has equipment that is not described, you will find the relevant description in a separate manual.

Technical data

All dimensions, weights and power outputs in the rider's manual refer to the German standard DIN (Deutsches Institut für Normung e. V.) and comply with its specified tolerances. Technical data and specifications in this rider's manual serve as reference points. The vehicle-specific data may deviate from these, for example as a result of selected optional equipment, the national-market version or country-specific measuring procedures. Detailed values can be taken from the vehicle registration documents and signs on the vehicle, or can be obtained from your authorised BMW Motorrad Retailer or

another qualified service partner or specialist workshop. The specifications in the vehicle documents always have priority over the information provided in this rider's manual.

Currentness

The high safety and quality level of BMW motorcycles is ensured by constant further development in the areas of design, equipment and accessories. This may result in deviations between these operating instructions and your motorcycle. Also, mistakes cannot be completely excluded by BMW Motorrad. Please therefore understand that we do not accept any liability for claims arising from incorrect information, drawings and descriptions.

Additional sources of information

BMW Motorrad Retailer

Your BMW Motorrad Retailer will be happy to answer any questions you may have.

Internet

The rider's manual for your vehicle, operating and installation instructions for any accessories and general information on BMW Motorrad, for example relating to technology, are available at **www.bmw-motorrad.com/service**.

Certificates and operating licences

The certificates for the vehicle and the official operating licences for any accessories are available at **www.bmw-motorrad.com/certification**.

Data memory

General

Control units are installed in the vehicle. Control units process data that they receive, for example, from vehicle sensors, or that they generate themselves or exchange between each other. Some control units are required for the vehicle to function safely or provide assistance during riding, for example assistance systems. In addition, control units enable comfort or infotainment functions.

Information on data that has been stored or exchanged can be obtained from the manufacturer of the vehicle, for example via a separate booklet.

Personal reference

Each vehicle is identified with a clear vehicle identification number. Depending on the country, the vehicle identification num-

ber, the number plate and the corresponding authorities can be referenced to ascertain the vehicle owner. There are also other ways to use data obtained from the vehicle to trace the rider or vehicle owner, for example using the ConnectedDrive user account.

Data protection rights

In accordance with applicable data protection laws, vehicle users have certain rights in relation to the manufacturer of the vehicle or in relation to companies which collect or process personal data.

Vehicle users have the right to obtain full information at no cost from persons or entities storing personal data of the vehicle user. These entities may include:

- Manufacturer of the vehicle
- Qualified service partners
- Specialist workshops
- Service providers

Vehicle users have the right to request information on what personal data has been stored, for what purpose the data is used, and where the data comes from. To obtain this information, proof of ownership or use is required. The right to information also includes information about data that has been shared with other companies or entities. The website of the vehicle manufacturer contains the applicable data protection information. This data protection information includes information on the right to have data deleted or corrected. The manufacturer of the vehicle also provides their contact details and those of the data protection officer on their website.

The vehicle owner can also request that a BMW Motorrad Retailer or another qualified service partner or specialist workshop read out the data that is stored in the vehicle for a charge.

The vehicle data is read out using the legally prescribed socket for on-board diagnosis (OBD) in the vehicle.

Legal requirements for the disclosure of data

As part of its legal responsibilities, the manufacturer of the vehicle is obligated to make its stored data available to the relevant authorities. This data is provided in the required scope in individual cases, for example to clarify a criminal offence. In the context of applicable laws, public agencies are entitled in individual cases to read out data from the vehicle themselves.

Operating data in the vehicle

Control units process data to operate the vehicle.

This includes, for example:

- Status reports of the vehicle and its individual components, for example wheel revolutions, wheel speed, deceleration
- Environmental conditions, for example temperature

The data is only processed in the vehicle itself and is generally non-permanent. The data is not stored beyond the operating period.

Electronic components, for example control units, contain components for storing technical information. Information can be temporarily or permanently stored on the vehicle condition, component loads, incidents or errors. This information is generally used to document the condition of a component, a module, a system

or the surrounding area, for example:

- Operating conditions of system components, for example filling levels, tyre pressure
- Malfunctions and faults in important system components, for example light and brakes
- Response of the vehicle in special riding situations, for example engagement of the driving dynamics systems
- Information on incidents resulting in damage to the vehicle

The data is necessary for the provision of control unit functions. Furthermore, the data is used to detect and rectify malfunctions and to enable the vehicle manufacturer to optimise vehicle functions.

The vast majority of this data is non-permanent and is only processed in the vehicle itself. Only a small amount of the data is

stored in incident or fault memories as required by events.

If services are accessed, for example repairs, service processes, warranty cases and quality assurance measures, this technical information can be read out of the vehicle together with the vehicle identification number.

The information can be read out by a BMW Motorrad Retailer or another qualified service partner or specialist workshop. The legally stipulated socket for on-board diagnosis (OBD) in the vehicle is used to read out the data.

The data is obtained, processed and used by the relevant parts of the retailer network. The data is used to document the technical conditions of the vehicle, to help with error localization, to comply with warranty obligations and to improve quality.

In addition, the manufacturer has various product monitoring obligations arising from product liability legislation. To meet these obligations, the vehicle manufacturer requires technical data from the vehicle. The data from the vehicle can also be used to check warranty claims from the customer.

Error and incident memories in the vehicle can be reset during servicing or repair work by a BMW Motorrad Retailer or another qualified service partner or specialist workshop.

Data input and data transfer in the vehicle

General

Depending on the equipment, comfort and customised settings can be stored in the vehicle and can be changed or reset at any time.

This includes, for example:

- Settings of the windscreen position
- Chassis and suspension settings

If required, data can be entered in the entertainment and communication system of the vehicle, for example using a smartphone.

Depending on the individual equipment, this includes:

- Multimedia data, such as music for playback
- Contacts data for use in connection with a communication system or an integrated navigation system
- Entered destinations
- Data on the use of internet services. This data can be stored locally in the vehicle or is located on a device that is connected to the vehicle, for example smartphone, USB stick, MP3 player. If this data is

stored in the vehicle, the data can be deleted at any time.

This data is transferred to third parties only if personally requested within the context of using online services. This depends on the selected settings when using the services.

Incorporation of mobile end devices

Depending on the equipment, mobile end devices connected to the vehicle, for example smartphones, can be controlled using the operating elements of the vehicle.

The image and sound of the mobile end device can then be output via the multimedia system. At the same time, specific information is transferred to the mobile end device. Depending on the type of integration, this includes, for example, position data and additional general vehicle information. This enables optimal

use of the selected apps, for example navigation or music playback.

The type of additional data processing is determined by the provider of the respective app. The scope of the possible settings depends on the corresponding app and the operating system of the mobile end device.

Services

General

If the vehicle has a wireless connection, this enables the exchange of data between the vehicle and other systems. The wireless connection is enabled by the vehicle's own transmitter and receiver unit or using personally integrated mobile end devices, for example smartphones. Online functions can be used using this wireless connection. These include online services and apps that are provided by the vehicle

manufacturer or by other providers.

Services of the vehicle manufacturer

For online services of the vehicle manufacturer, the individual functions are described at suitable points, for example rider's manual, website of the manufacturer. At the same time, information is also provided on the relevant data protection law. Personal data may be used to provide online services. Data is exchanged using a secure connection, for example with the IT systems provided by the vehicle manufacturer.

Obtaining, processing and using personal data outside of the normal provision of services requires legal permission, contractual agreement or consent. It is also possible to have the entire data connection activated or de-

activated. Statutory functions are excluded from this.

Services from other providers

When using online services from other providers, these services are subject to the responsibility and the data protection and operating conditions of the individual provider. The vehicle manufacturer has no influence on the content that is exchanged in this instance. Information on the type, scope and purpose of the data capture and use of personal data as part of the services of third parties can be ascertained from the individual provider.

General views

General view, left side.....	15
General view, right side	17
Underneath the seat	18
Multifunction switch, left	19
Multifunction switch, right.....	21
Instrument panel	23

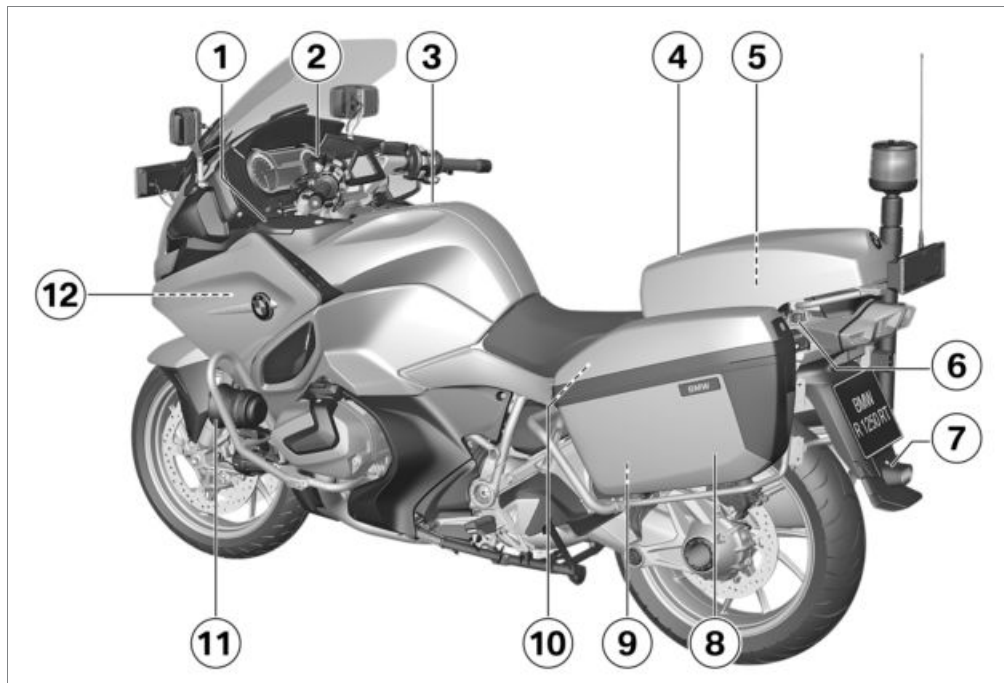

General view, left side

- 1** Storage compartment, left (➡ 103)
- 2** Clutch-fluid reservoir (➡ 160)
- 3** Fuel filler neck (➡ 130)
- 4** Radio transceiver box (➡ 195)
- 5** Radio preparation (➡ 195)
Mobile radio system
Intercom system in the radio transceiver box (➡ 77)
Auxiliary battery (➡ 181)
- 6** Plug
– with power socket^{OE}
2nd socket
- 7** Rear fog light (➡ 68)
- 8** Cases (➡ 191)
Case for special vehicle (➡ 193)
- 9** Rider's manual in the case
Fire extinguisher in the case (➡ 194)
- 10** Seat lock (➡ 100)
- 11** Hailing system (➡ 75)
Emergency power siren (➡ 76)
- 12** Payload table
Table of tyre pressures

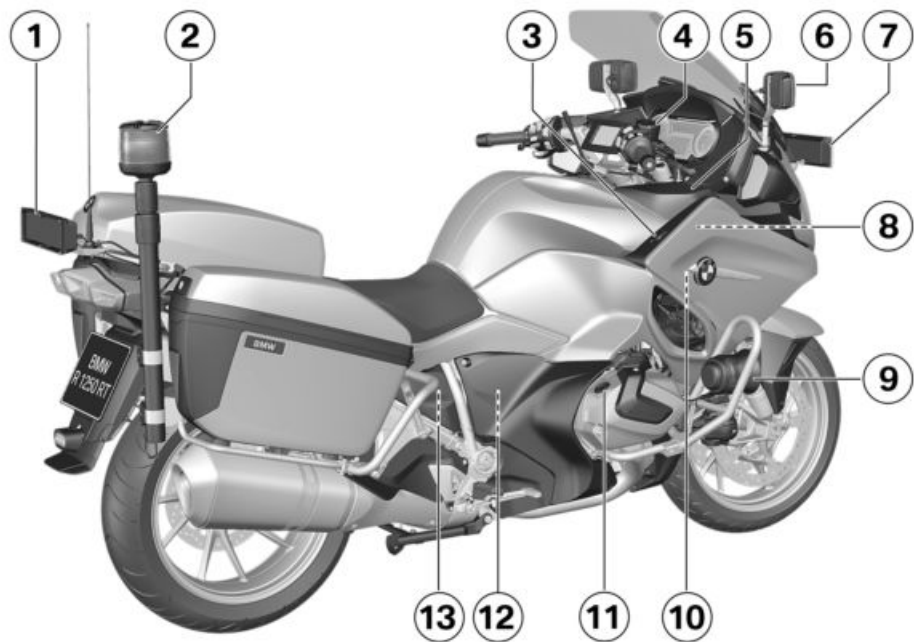

General view, right side

- 1 Rear STOP signal (➡ 73)
- 2 LED 360° marker strobe (➡ 71)
- 3 Power socket (➡ 190)
- 4 Brake-fluid reservoir, front (➡ 158)
- 5 Cover
- 6 LED flashing warning lights (➡ 69)
- 7 Front STOP signal (➡ 72)
- 8 Vehicle identification number (on the steering-head bearing)
Type plate (on the steering-head bearing)
- 9 Hailing system (➡ 75)
Emergency power siren (➡ 76)
Intercom system (➡ 77)
- 10 Coolant level indicator (behind the side trim panel) (➡ 160)
- 11 Engine-oil filler neck (➡ 154)
- 12 Behind the engine spoiler:
Battery (➡ 177)
Remote positive terminal (➡ 176)
Diagnostic connector (➡ 187)
- 13 Brake fluid tank rear (behind the side trim panel) (➡ 159)

Underneath the seat

- 1 Adjuster for front-seat height (➔ 101)
- 2 Standard toolkit (➔ 152)
- 3 Tool for adjusting the spring preload (➔ 113)
- 4 Fuses (➔ 185)

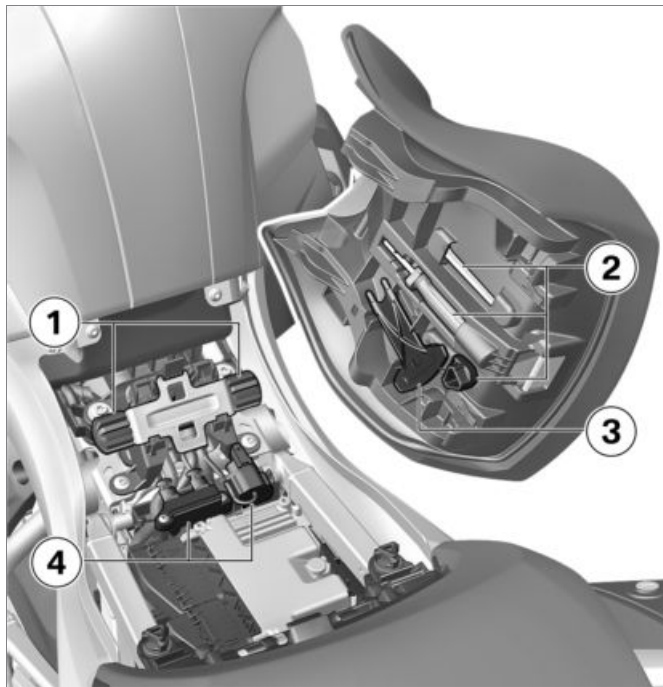



Multifunction switch, left

- 1 High-beam headlight and headlight flasher (► 63)
- 2 – with daytime riding light^{OE}
- 3 Manual daytime riding light (► 66).
– with cruise control^{OE}
- 4 Cruise-control system (► 89).
- 5 Hazard warning lights system (► 68)
- 6 Windscreen adjuster (► 110)
- 7 – with STOP signal, front^{OE}
or
– with STOP matrix sign and YELP sound^{OE}
- 8 Front stop signal (► 72).
– with additional headlight^{OE}
- 9 LED auxiliary headlights (► 64).

- 7** – with hailing system, electronic^{OE}
Hailing system (▣▣▣ 75).
Sound 1 and sound 2
– with siren, electronic^{OE}
Siren (▣▣▣ 76).
- 8** – with hailing system, electronic^{OE}
Hailing system (▣▣▣ 75).
Sound 3 and sound 4
– with siren, electronic^{OE}
Siren (▣▣▣ 76).
- 9** Turn indicators (▣▣▣ 69)
- 10** Function keys (encodable according to equipment and customer request: encoding for function keys, see Technical Data)
Cruising Light (▣▣▣ 66)
– with radio preparation^{OE}
Mobile radio system (see corresponding operating instructions)
- 11** Horn
- 12** Multi-Controller and MENU button
Multifunction display (▣▣▣ 78)
ASC (▣▣▣ 85)
– with Dynamic ESA^{OE}
D-ESA (▣▣▣ 87)
– with radio preparation^{OE}
Mobile radio system (see corresponding operating instructions)
- 13** Favourite menu (▣▣▣ 81).



Multifunction switch, right

- 1** – with central locking system^{OE}
Central locking (➡ 103).
- 2** Riding mode (➡ 88)
- 3** Emergency off switch (kill switch) (➡ 62)
- 4** Start engine (➡ 121)
- 5** Function buttons (codable, depending on equipment fitted and customer request: see the section entitled "Technical data" for information on coding for function buttons)
 - with km/h instrument cluster for special vehicle^{OE}
Saving road speed (➡ 84).
 - with radio preparation^{OE}
Two-way radio system (see the appropriate operating instructions)

- 6** – with STOP signal^{OE}
Rear stop signal (▣▣▣▶ 73).
- 7** – with LED flashing warning light^{OE}
Front LED flashing warning light (▣▣▣▶ 69).
– with LED 360° marker strobe^{OE}
Using the 360° marker strobe (▣▣▣▶ 71).
- 8** – with rear fog light^{OE}
Operate the rear fog light (▣▣▣▶ 68).
– with light deactivation^{OE}
Lights-off setting (▣▣▣▶ 75).

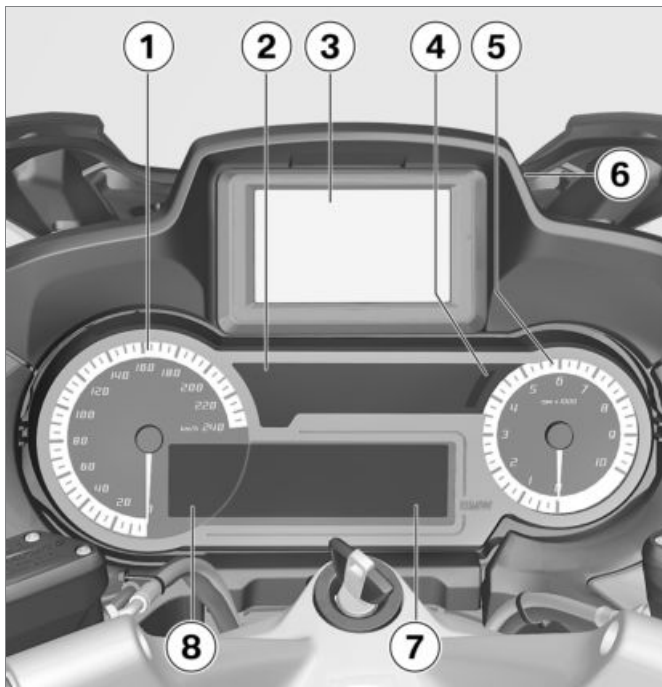

Instrument panel

- 1 Speedometer
- 2 Indicator and warning lights (➡ 26)
- 3 – with navigation system^{OA}
– with preparation for navigation system^{OE}
Navigation device (➡ 199).
- 4 Photosensor (for adapting the brightness of the instrument lighting)
- 5 Engine speed display
- 6 Unlocking for navigation shaft (➡ 199)
- 7 Multifunction display (➡ 29)
- 8 Trip recorder (➡ 84)



NOTICE

The brightness of the warning lights and indicator lights, the display and the instrument needle and gauge lighting is

adapted automatically to suit ambient brightness. ◀

Status indicators

Indicator and warning lights	26
Meaning of symbols	27
Multifunction display	29
Warnings	30
Service-due indicator	49
Range	50
Electronic oil-level check.....	50
Ambient temperature	51
Tyre pressures.....	51
Authorities speed indicator.....	52

Indicator and warning lights

- 26
- 1 ABS (►►► 44)
 - 2 ASC (►►► 45)
 - with riding modes Pro^{OE} DTC (►►► 45)
 - 3 Turn indicators, left
 - 4 Fuel reserve (►►► 49)
 - 5 - with daytime riding light^{OE}
 - Manual daytime riding light (►►► 66).
 - 6 High-beam
 - 7 Turn indicators, right
 - 8 - with export to EU markets^{NV}
 - Malfunction indicator lamp
 - Emissions warning (►►► 38)
 - 9 - with anti-theft alarm (DWA)^{OE}
 - DWA (►►► 94).

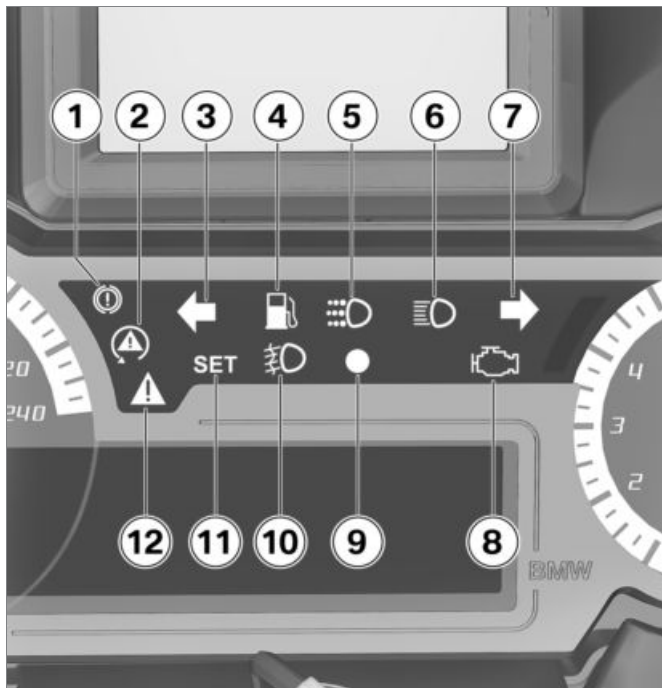



- 10 – with additional headlight^{OE}
LED auxiliary headlights (➡ 64).
- 11 – with cruise control^{OE}
Cruise-control system (➡ 89).
- 12 General warning light, in connection with warning symbols in the display (➡ 30)

Meaning of symbols



Meaning of the symbols at position **1**:

-  Average consumption since the last reset (➡ 82)
-  Current consumption
-  Range with the available fuel quantity (➡ 50)

 Average speed since the last reset (➡ 82)

 Ambient temperature (➡ 51)

– with tyre pressure control (RDC)^{OE}

 Tyre inflation pressures (➡ 51)

 Stopwatch (➡ 83)

 Travelling times (➡ 83)

 Date (display depends on the configured time format) (➡ 81)



Oil level (→ 50)



On-board voltage



1 Heated grips switched on

– with seat heating^{OE}



1 Rider's seat heating switched on

– with Dynamic ESA^{OE}



1 Damping mode
2 Load setting

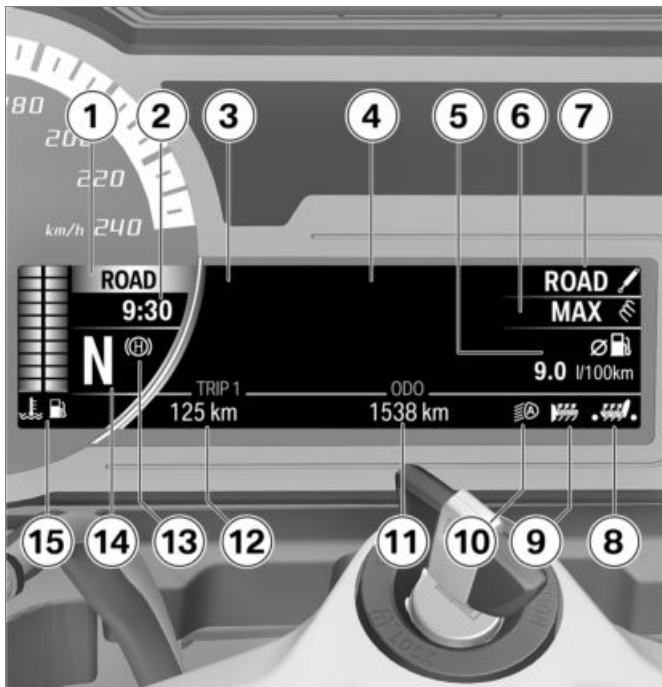

Multifunction display

- 1 Riding mode (➡ 88)
- 2 Clock (➡ 81)
- 3 Warning symbols (➡ 30)
- 4 Menu section (➡ 78)
Audio system
- 5 On-board computer (➡ 82)
– with tyre pressure control (RDC)^{OE}
Tyre pressure
- 6 Load setting (➡ 87)
- 7 Damping mode (➡ 87)
- 8 Rider's seat heating (➡ 99)
- 9 Heated handlebar grips (➡ 98)
- 10 Automatic daytime riding light (➡ 67)
- 11 Odometer
- 12 Trip recorder (➡ 84)
- 13 Hill Start Control (➡ 91)
- 14 Gear indicator; "N" indicates neutral.

- 15** Coolant temperature
Fuel level

Warnings

Mode of presentation

Warnings are indicated by the corresponding warning lights.



Warnings for which there are no separate warning lights are shown using the general warning light **1** in combination with a warning symbol such as **2** on the multifunction display. The 'general' warning light is yellow or red, depending on the urgency of the warning.

Up to four warning symbols can be displayed at the same time.

The general warning light is displayed according to the most urgent warning .













The possible warnings are listed on the following pages.

Warnings, overview

Indicator and warning lights

Display text















Meaning













		appears on the display	Outside temperature warning (→ 37)
 lights up yellow		appears on the display	EWS active (→ 37)
 lights up yellow		appears on the display	Radio-operated key out of range (→ 37)
 lights up yellow			Replace the battery of the radio-operated key (→ 38)
 lights up red		Temperature display turns red.	Coolant temperature too high (→ 38)
		appears on the display	Engine-oil level too low (→ 38)
 Malfunction indicator lamp lights up			Emissions warning (→ 38)
 lights up yellow		appears on the display	Engine fault (→ 39)









Indicator and warning lights

Display text

Meaning

	flashes yellow		appears on the display	Severe engine fault (→ 39)
	lights up yellow		appears on the display	Front light failure (→ 40)
	lights up yellow		appears on the display	Rear light failure (→ 40)
	lights up yellow		appears on the display	Light failure (→ 40)
			appears on the display	DWA battery weak (→ 40)
	lights up yellow		appears on the display	DWA battery flat (→ 41)
			appears on the display	On-board system voltage low (→ 41)
	lights up yellow		appears on the display	On-board system voltage critical (→ 41)











Indicator and warning lights	Display text	Meaning
 lights up red	 appears on the display	Battery charge voltage insufficient (►►► 42)
		LED auxiliary headlights (►►► 42)
 flashes red	 + tyre pressure in red	Tyre pressure outside the permitted tolerance (►►► 42)
 lights up yellow	 + "--" or "-- --" appears on the display	Sensor faulty or system fault (►►► 43)
	 + "--" or "-- --" appears on the display	Transmission fault (►►► 43)
 lights up yellow	 appears on the display	Battery for tyre pressure sensor weak (►►► 44)
 flashes		ABS self-diagnosis not completed (►►► 44)
 lights up		ABS fault (►►► 44)

Indicator and warning lights	Display text	Meaning
	lights up	ABS deactivated (→ 45)
	quick-flashes	ASC intervention (→ 45)
	quick-flashes	DTC intervention (→ 45)
	slow-flashes	ASC self-diagnosis not completed (→ 45)
	slow-flashes	DTC self-diagnosis not completed (→ 46)
	lights up	ASC switched off (→ 46)
	lights up	DTC switched off (→ 46)
	lights up	ASC fault (→ 46)

Indicator and warning lights

Display text

Meaning

 lights up		DTC fault (►►► 46)
 lights up yellow	 appears on the display	D-ESA fault (►►► 47)
	 Green holding symbol is displayed.	Hill Start Control active (►►► 47)
	 White holding symbol is displayed.	Automatic Hill Start Control Pro active (►►► 47)
	 Yellow holding symbol is displayed.	Hill Start Control cannot be activated. (►►► 47)
 flashes yellow	 Yellow holding symbol flashes briefly.	Hill Start Control automatically deactivated (►►► 48)
	 appears on the display	Central locking locked (►►► 48)
	 The gear indicator flashes.	Gear not calibrated (►►► 48)

Indicator and warning lights**Display text****Meaning**

briefly shows yellow



appears on the display

Service overdue (||||▶ 49)



lights up

Fuel-level reading turns yellow

Fuel down to reserve (||||▶ 49)

Outside temperature warning



appears on the display

Possible cause:



The air temperature measured at the vehicle is lower than:

approx. 3 °C



WARNING

Risk of black ice also applicable at over 3 °C

Risk of accident

- Always take extra care when temperatures are low; remember that there is particular danger of black ice forming on bridges and where the road is in shade.◀
- Ride carefully and think well ahead.

EWS active



lights up yellow.



appears on the display.

Possible cause:

The key being used is not authorised for starting, or communication between key and engine electronics is disrupted.

- Remove all other vehicle keys from the same ring as the ignition key.
- Have the defective key replaced, preferably by an authorised BMW Motorrad dealer.

Radio-operated key out of range

– with Keyless Ride^{OE}



lights up yellow.



appears on the display.

Possible cause:

Communication between R/C key and engine electronics is disrupted.

- Check the battery in the radio-operated key.
 - with Keyless Ride^{OE}
- Replace the battery of the radio-operated key (►► 61).
- Use the emergency key or the radio-operated key with the empty battery to continue your journey.
 - with Keyless Ride^{OE}
- Battery of the radio-operated key is empty, emergency key is not available (►► 60).
- Loss of the radio-operated key, emergency key is available (►► 60).
- Remain calm if the warning symbol appears while you are

riding. You can continue your journey, the engine will not switch off.

- Have the defective radio-operated key replaced by an authorised BMW Motorrad dealer.

Replace the battery of the radio-operated key



lights up yellow.



The battery symbol appears on the display.

Possible cause:

- The integral battery in the radio-operated key has lost a significant proportion of its original capacity. There is no assurance of how long the R/C key can remain operational.
- with Keyless Ride^{OE}
- Replace the battery of the radio-operated key (►► 61).

Coolant temperature too high



lights up red.

The temperature reading turns red.



ATTENTION

Riding with overheated engine

Engine damage

- Compliance with the information set out below is essential.◀

Possible cause:

The coolant temperature is too high.

- If possible, ride in the part-load range to cool down the engine.
- If the coolant temperature is frequently too high, have the fault rectified as soon as possible by a specialist workshop, preferably an

authorised BMW Motorrad dealer.

Engine-oil level too low



appears on the display.

Possible cause:

The electronic oil-level sensor has registered an excessively low oil level. The next time you stop for fuel:

- Checking engine oil level (►► 154).

If the oil level is too low:

- Topping up the engine oil (►► 155).

If the oil level is correct:

- Seek the advice of a specialist workshop, preferably an authorised BMW Motorrad dealer.

Emissions warning



Malfunction indicator lamp lights up

Possible cause:

The engine control unit has diagnosed a fault which affects the pollutant emissions.

- Have the fault rectified by a specialist workshop, preferably an authorised BMW Motorrad dealer.
- » You can continue riding; pollutant emissions are higher than the threshold values.

Engine fault



lights up yellow.



appears on the display.

Possible cause:

The engine control unit has diagnosed a fault.

WARNING

Unusual ride characteristics when engine running in emergency-operation mode

Risk of accident

- Avoid accelerating sharply and overtaking.◀
- If you continue to ride be prepared for unusual engine behaviour (low power, poor throttle response, abrupt stalling, etc.).
- Have the fault rectified as quickly as possible by a specialist workshop, preferably an authorised BMW Motorrad dealer.

Severe engine fault



flashes yellow.



appears on the display.

Possible cause:

The engine control unit has diagnosed a severe fault.

WARNING

Engine damage when running in emergency-operation mode

Risk of accident

- Ride slowly, avoid accelerating sharply and overtaking.
- If possible, have the vehicle picked up and have the fault rectified by a specialist workshop, preferably an authorised BMW Motorrad Retailer.◀
- If you continue to ride be prepared for unusual engine behaviour (low power, poor throttle response, abrupt stalling, etc.).
- Have the fault rectified as quickly as possible by a specialist workshop, preferably an authorised BMW Motorrad dealer.

Front light failure



lights up yellow.



appears on the display.

Possible cause:

Low-beam headlight, high-beam headlight, parking light or front flashing turn indicator defective. Lights-off setting active.

The low-beam headlight or one of the LED turn indicators must be replaced.

- Consult a specialist workshop, preferably an authorised BMW Motorrad dealer.
- Replacing bulb for high-beam headlight (➡ 173).

Rear light failure



lights up yellow.



appears on the display.

Possible cause:

Rear light, brake light or rear flashing turn indicator defective. The LED rear light must be replaced.

- Consult a specialist workshop, preferably an authorised BMW Motorrad dealer.

Light failure



lights up yellow.



appears on the display.

Possible cause:

A combination of light failures has occurred.

- Consult a specialist workshop, preferably an authorised BMW Motorrad dealer.

DWA battery weak

– with anti-theft alarm (DWA)^{OE}



appears on the display.



NOTICE

This error message shows briefly only after the Pre-Ride-Check completes. ◀

Possible cause:

The integral battery in the anti-theft alarm (DWA) has lost a significant proportion of its original capacity. There is no assurance of how long the DWA anti-theft alarm can remain operational if the vehicle's battery is disconnected.

- Seek the advice of a specialist workshop, preferably an authorised BMW Motorrad dealer.

DWA battery flat

– with anti-theft alarm (DWA)^{OE}



lights up yellow.



appears on the display.



NOTICE

This error message shows briefly only after the Pre-Ride-Check completes. ◀

Possible cause:

The integral battery in the anti-theft alarm (DWA) has lost its entire original capacity. There is no assurance that the DWA anti-theft alarm will be operational if the vehicle's battery is disconnected.

- Seek the advice of a specialist workshop, preferably an authorised BMW Motorrad dealer.

On-board system voltage low



appears on the display.

Generator power is only just sufficient to supply all consumers and charge the battery.

Possible cause:

Too many consumers switched on. On-board system voltage tends to drop particularly at low engine rpm and when the engine is idling.

- When riding at low engine rpm switch off all consumers that are not necessary for road safety (e.g. heated body warmer or auxiliary headlights).

On-board system voltage critical



lights up yellow.



appears on the display.

Generator power is no longer sufficient to supply all consumers and charge the battery. In order to ensure that the engine can be started and the motorcycle ridden, the on-board electronics switch off the electricity supply to the on-board sockets and the auxiliary headlights. In extreme cases the seat heating and the grip heating might also be shut down.

Possible cause:

Too many consumers switched on. On-board system voltage tends to drop particularly at low engine rpm and when the engine is idling.

- When riding at low engine rpm switch off all consumers that are not necessary for road safety (e.g. heated body warmer or auxiliary headlights).

Battery charge voltage insufficient



lights up red.



appears on the display.



WARNING

Failure of the vehicle systems

Risk of accident

- Do not continue your journey. ◀

Battery is not being charged. If you continue to ride the vehicle the on-board electronics will drain the battery.

Possible cause:

Alternator or alternator drive faulty or fuse for alternator regulator has blown.

- Have the fault rectified as quickly as possible by a specialist workshop, preferably

an authorised BMW Motorrad dealer.

LED auxiliary headlights

– with additional headlight^{OE}



The telltale light shows.



If this warning symbol appears it tells you that the on-board system voltage is low. If applicable, the auxiliary headlights might have been temporarily switched off.

Tyre pressure outside the permitted tolerance

– with tyre pressure control (RDC)^{OE}



flashes red.



+ the critical tyre pressure shows red.

Possible cause:

Measured tyre pressure is outside permitted tolerance.

- Check the tyre for damage and to ascertain whether the vehicle can be ridden with the tyre in its present condition.

If the vehicle can be ridden with the tyre in its present condition:

- Correct the tyre pressure at the earliest possible opportunity.



NOTICE

Before adjusting the tyre pressure, observe the information on temperature compensation and pressure adaptation in the section entitled "Engineering details": ◀

- Have the tyre checked for damage by a specialist workshop, preferably an authorised BMW Motorrad dealer.

If you are unsure whether the vehicle can be ridden with the tyre in its present condition:

- Do not continue your journey.
- Notify the breakdown service.

Sensor faulty or system fault

– with tyre pressure control (RDC)^{OE}



lights up yellow.



+ "---" or "-- --" appears on the display.

Possible cause:

Motorcycle is fitted with wheels not equipped with RDC sensors.

- Fit wheels and tyres equipped with RDC sensors.

Possible cause:

1 or 2 RDC sensors have failed or a system error has occurred.

- Have the fault rectified by a specialist workshop, preferably an authorised BMW Motorrad dealer.

Possible cause:

A system error has occurred.

- Have the fault rectified by a specialist workshop, preferably an authorised BMW Motorrad dealer.

Transmission fault

– with tyre pressure control (RDC)^{OE}



+ "---" or "-- --" appears on the display.

Possible cause:

The vehicle did not reach the minimum required speed (→ 146).



RDC sensor is not active

min 30 km/h (The RDC sensor does not transmit its signal to the vehicle until a certain minimum speed has been reached.)

- Increase speed above this threshold and observe the RDC readings. Assume that a permanent fault has not occurred unless the 'General' warning light comes on to accompany the symptoms. Under these circumstances:
- Have the fault rectified by a specialist workshop, preferably an authorised BMW Motorrad dealer.

Possible cause:

Wireless communication with the RDC sensors has been disrupted. Possible causes include radio-communication systems operat-

ing in the vicinity and interfering with the link between the RDC control unit and the sensors.

- Move to another location and observe the RDC readings. Assume that a permanent fault has not occurred unless the 'General' warning light comes on to accompany the symptoms. Under these circumstances:
- Have the fault rectified by a specialist workshop, preferably an authorised BMW Motorrad dealer.

Battery for tyre pressure sensor weak

– with tyre pressure control (RDC)^{OE}



lights up yellow.



appears on the display.



NOTICE

This error message shows briefly only after the Pre-Ride-Check completes. ◀

Possible cause:

The integral battery in the tyre-pressure sensor has lost a significant proportion of its original capacity. There is no assurance of how long the tyre pressure control system can remain operational.

- Seek the advice of a specialist workshop, preferably an authorised BMW Motorrad dealer.

ABS self-diagnosis not completed



flashes.

Possible cause:



ABS self-diagnosis not completed

The ABS function is not available, because self-diagnosis did not complete. (The motorcycle has to reach a defined minimum speed for the wheel speed sensors to be checked: 5 km/h)

- Pull away slowly. Bear in mind that the ABS function is not available until self-diagnosis has completed.

ABS fault



lights up.

Possible cause:

The ABS control unit has detected a fault. The partially integral brake and the Dynamic Brake Control function have failed. The ABS function is not available.

- It is possible to continue riding taking the failed ABS function into consideration. Take note of the further information on situations that may lead to an ABS fault (▣▣▣ 137).
- Have the fault rectified as quickly as possible by a specialist workshop, preferably an authorised BMW Motorrad Retailer.

ABS deactivated

– with US authority^{OE}



lights up.

Possible cause:

The rider has switched off the ABS system.

- Activate the ABS function.

ASC intervention



quick-flashes.

The ASC has detected a degree of instability at the rear

wheel and has intervened to reduce torque. The indicator and warning light flashes for longer than ASC intervention lasts. This affords the rider visual feedback on control intervention even after the critical situation has been dealt with.

DTC intervention

– with riding modes Pro^{OE}



quick-flashes.

The DTC has detected a degree of instability at the rear wheel and has intervened to reduce torque. The indicator and warning light flashes longer than the DTC intervention lasts. This affords the rider visual feedback on control intervention even after the critical situation has been dealt with.

ASC self-diagnosis not completed



slow-flashes.

Possible cause:



ASC self-diagnosis not completed

The ASC function is not available, because self-diagnosis did not complete. (The motorcycle has to reach a defined minimum speed for the wheel sensors to be checked: min 5 km/h)

- Pull away slowly. Bear in mind that the ASC function is not available until self-diagnosis has completed.

DTC self-diagnosis not completed

– with riding modes Pro^{OE}



slow-flashes.

Possible cause:



DTC self-diagnosis not completed

The DTC function is not available, because self-diagnosis did not complete. (The motorcycle has to reach a defined minimum speed with the engine running for the wheel-speed sensors to be checked: min 5 km/h)

- Pull away slowly. Bear in mind that the DTC function is not available until self-diagnosis has completed.

ASC switched off



lights up.

Possible cause:

The rider has switched off the ASC system.

- Switch on ASC.

DTC switched off

– with riding modes Pro^{OE}



lights up.

Possible cause:

The rider has switched off the DTC system.

- Switching the DTC function off/on (►► 86).

ASC fault



lights up.

Possible cause:

The ASC control unit has detected a fault. The ASC function is not available.

- You can continue to ride. Bear in mind that the ASC function is not available. Bear in mind the more detailed information on situations that can lead to an ASC fault (►► 140).
- Have the fault rectified as quickly as possible by a specialist workshop, preferably an authorised BMW Motorrad dealer.

DTC fault

– with riding modes Pro^{OE}



lights up.

Possible cause:

The DTC control unit has detected a fault. The DTC function is not available.

- You can continue to ride. Bear in mind that the DTC function is not available. Bear in mind the more detailed information on situations that can lead to a DTC fault (▣▣▣ 141).
- Have the fault rectified as quickly as possible by a specialist workshop, preferably an authorised BMW Motorrad dealer.

D-ESA fault



lights up yellow.



appears on the display.

Possible cause:

The D-ESA control unit has detected a fault. The damping and/or spring adjuster may be the cause. In Auto the cause may also be a fault in the riding position equaliser. In this condition, the motorcycle may have too

much damping and is uncomfortable to drive, especially on roads in poor condition. Alternatively, the spring setting may be set incorrectly.

- Have the fault rectified as quickly as possible by a specialist workshop, preferably an authorised BMW Motorrad Retailer.

Hill Start Control active



Green holding symbol is displayed.

Possible cause:

Hill Start Control (▣▣▣ 149) has been activated automatically or activated by the rider.

- Operate Hill Start Control (▣▣▣ 91).
- with riding modes Pro^{OE}
- Switching automatic Hill Start Control Pro on and off (▣▣▣ 94).

Automatic Hill Start Control Pro active

– with riding modes Pro^{OE}



White holding symbol is displayed.

Possible cause:

The automatic Hill Start Control Pro is active. If the motorcycle stops on an incline of > 5%, the motorcycle is automatically held in place by the brakes.

- Switch off automatic Hill Start Control Pro.
- Switching automatic Hill Start Control Pro on and off (▣▣▣ 94).

Hill Start Control cannot be activated



Yellow holding symbol is displayed.

Possible cause:

Hill Start Control cannot be activated.

- Fold in side stand.
- » Hill Start Control functions only when the side stands are folded in.
- Start the engine.
- » Hill Start Control functions only when the engine is running.

Hill Start Control automatically deactivated



flashes yellow.



Yellow holding symbol flashes briefly.

Possible cause:

Hill Start Control has been automatically deactivated.

- Side stand has been folded out.

- » Hill Start Control is deactivated when the side stand is folded out.
- Engine has been switched off.
- » Hill Start Control is deactivated when the engine is switched off.
- Operate Hill Start Control (▬▶ 91).

Central locking locked

– with central locking system^{OE}



The locked symbol appears on the display.

All locks in the central locking system are locked.

Gear not calibrated

– with shift assistant Pro^{OE}



The gear indicator flashes. The shift assistant Pro is not available.

Possible cause:

– with shift assistant Pro^{OE}

The transmission sensor has not been completely calibrated.

- Engage idle position **N** and run the engine at standstill for a minimum of 10 seconds to calibrate the idle position.
- Use clutch control to engage all gears and ride for a minimum of 10 seconds in each engaged gear.
- » The gear indicator stops flashing once the transmission sensor has been successfully calibrated.
- Once the transmission sensor has been completely calibrated, shift assistant Pro will operate as described (▬▶ 147).
- If the calibration process was unsuccessful, have the fault eliminated by a specialist workshop, we recommend a BMW Motorrad Partner.

Service overdue



appears on the display.



General warning light briefly shows yellow after the Pre-Ride-Check.

Possible cause:

A necessary service has not been carried out.

- Have servicing carried out as quickly as possible by a specialist workshop, preferably an authorised BMW Motorrad dealer.

Fuel down to reserve



lights up.

Fuel-level reading turns yellow.



WARNING

Irregular engine operation or engine shutdown due to lack of fuel

Risk of accident, damage to catalytic converter

- Do not run the fuel tank dry. ◀

Possible cause:

The fuel tank contains no more than the reserve quantity of fuel.



Reserve fuel

approx. 4 l

- Refuelling (▶▶▶ 130).

Service-due indicator



If a service is due, the service symbol and the service date in place of the total distance are briefly displayed subsequent to the Pre-Ride-Check.



If the service is overdue the 'General' warning light briefly shows yellow and the service symbol lights up and remains ON.

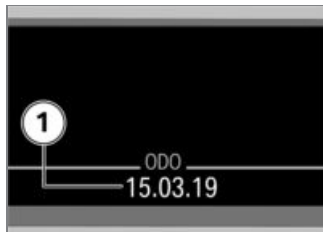

If the countdown to the next service is less than one month, the service-due date **1** appears on the display.

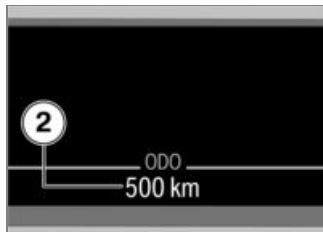

If the vehicle covers long distances in the course of the year, under certain circumstances it

might be necessary to have it serviced at a date in advance of the forecast due date. If the countdown distance to the early service is less than 1000 km, the countdown distance **2** appears on the display.



NOTICE

If the service-due indicator appears more than a month before the service date, the current date has to be corrected. This situation can occur if the battery was disconnected.◀

Range



The range readout indicates how far you can ride with the fuel remaining in the tank. The figure for average consumption used to calculate range is not shown and might not be the same as the average-con-

sumption reading that appears on the display.

You must put at least five litres of fuel into the fuel tank for the new level to be registered correctly. If the sensor cannot register the new level the range readout cannot be updated.

When the motorcycle is propped on its side stand the slight angle of inclination means that the sensor cannot register the fuel level correctly. This is the reason why the range is calculated only when the side stand is in the retracted position.



NOTICE

The calculated range is only an approximate figure. Consequently, BMW Motorrad recommends that you should not try to use the full range before refuelling.◀

Electronic oil-level check



The electronic oil-level check provides information about the oil level in the engine.

The preconditions for the electronic oil-level check are as follows:

- Engine at operating temperature.
- Engine idling for at least ten seconds.
- No brake applied.
- Side stand folded in.
- Motorbike standing upright.

The readings mean:

OK: oil level is correct.

CHECK!: check the oil level the next time you stop for fuel.

-- -: oil level cannot be measured (conditions as stated above not satisfied).

Ambient temperature



When the motorcycle is at a standstill the heat of the engine can falsify the ambient-temperature reading. If the effect of the engine's heat becomes excessive, "--" temporarily appears on the display.



If ambient temperature drops below the threshold this warning appears, drawing your attention to the risk of black ice forming. The display automatically switches from any other mode to the temperature reading when the temperature drops below this threshold for the first time.



Threshold for ambient temperature

approx. 3 °C

Tyre pressures

– with tyre pressure control (RDC)^{OE}

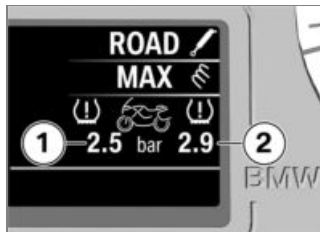

The tyre-pressure readings in the multifunction display are temperature-compensated and are always referenced to the following tyre-air temperature:

20 °C

The left value **1** indicates the filling pressure of the front wheel; the right value **2** indicates the filling pressure of the rear wheel. Immediately after the ignition is switched on "-- --" is displayed.



RDC sensor is not active

min 30 km/h (The RDC sensor does not transmit its signal to the vehicle until a certain minimum speed has been reached.)

In the event of a critical tyre inflation pressure, the relevant display appears red.



The tyre warning symbol is also displayed.



The general warning light flashes red.

You can find further information about BMW Motorrad RDC from page (➔ 146).

Authorities speed indicator

– with km/h instrument cluster for special vehicle^{OE}



- 1 True speed without speedometer lead
- 2 Saved speed (➔ 84)

Operation

Ignition switch/steering lock	54	Automatic Stability Control (ASC)	85
Ignition with Keyless Ride	56	Dynamic Traction Control (DTC)	86
Emergency off switch (kill switch)	62	Electronic Suspension Adjustment (D-ESA)	87
Lights	63	Riding mode	88
Day run lights	66	Cruise-control system	89
Hazard warning lights system	68	Hill Start Control	91
Turn indicators	69	Anti-theft alarm (DWA)	94
Light signals	69	Heating	98
Sound signals	75	Front seat	100
Multifunction display	78	Rear seat	101
On-board computer	82	Adjusting spray guard	102
Authorities speed indicator	83	Stowage compartment	103
Trip recorder	84	Central locking system	103
Antilock Brake System (ABS)	85		

Ignition switch/steering lock

Keys

You receive 2 ignition keys. Consult the information on the electronic immobiliser (EWS) (► 56) if a key is lost or mislaid.

One-key system

- Ignition switch/steering lock
- Cases locks
- Stowage-compartment lock
- Tank filler cap
- Seat lock
- Stowage compartment

- with topcase^{OA}
- Topcase

Lock the handlebars

- Turn the handlebars all the way to left.

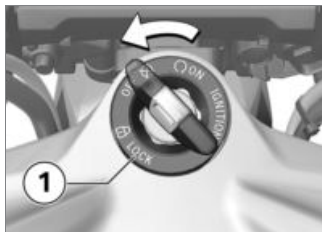

- Turn the key to position **1**, while moving the handlebars slightly.
 - » Ignition, lights and all function circuits switched off.
 - » Handlebars are locked.
 - » Key can be removed.

Switching on ignition



- Insert the key into the ignition steering lock and turn it to position **1**.
 - » Side lights and all function circuits are switched on.
 - » Pre-Ride-Check is performed. (► 121)
 - » ABS self-diagnosis is in progress. (► 122)
 - » ASC self-diagnosis is performed. (► 123)
- with riding modes Pro^{OE}
 - » DTC self-diagnosis is in progress. (► 123)◁

Welcome lights

- Switch on the ignition.
 - » The side lights briefly light up.
 - with daytime riding light^{OE}
 - » The daytime riding lights briefly light up.<
 - with additional headlight^{OE}
 - » The LED auxiliary headlights briefly light up.<

Special functions

- with auxiliary battery^{OE}

Important special functions can still be used after the ignition has been switched off.

Operation is subject to a time limit or can be sustained until the auxiliary battery is drained.

Auxiliary battery plug connection

- with auxiliary battery^{OE}

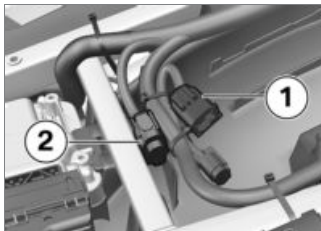

It is required to insert the bridge **1** into the isolation connector during the pre-delivery check **2** to operate the auxiliary battery and the associated special functions.

Remove the driver's seat (➡ 100) as well as the passenger seat (➡ 101) and/or seat wedge (➡ 182) to check the plug connection for the auxiliary battery.

Important special functions:

- Release for radio transceiver box
- LED 360°marker strobes
- LED marker strobe
- Public-address system
- Two-way radio
- US contents

Switching off ignition

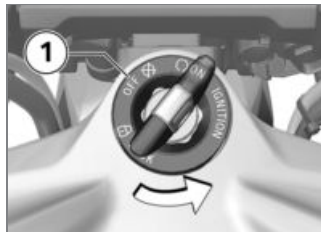

- Turn the ignition key to position **1**.
 - » When the ignition is switched off, the instrument cluster remains switched on for a short time and displays any existing fault messages.

- » Handlebars not locked.
 - » Electrically powered accessories remain operational for a limited period of time.
 - » The battery can be recharged via the socket.
 - » Key can be removed.
- with daytime riding light^{OE}
 - The daytime riding light goes out soon after the ignition is switched off.<
 - with additional headlight^{OE}
 - The LED auxiliary headlights go out soon after the ignition is switched off.<

Electronic immobiliser EWS

The electronic design of the motorcycle allows it to access data stored in the ignition key by means of a ring antenna located in the ignition switch/steering lock. The engine control unit

will not permit the engine to be started unless the key is identified as “authorised”.



NOTICE

A spare key attached to the same ring as the ignition key used to start the engine could “irritate” the electronics, in which case the enabling signal for starting is not issued. The warning is displayed on the multifunction display with the key symbol.

Always keep the spare key separately from the ignition key.<

If you lose a key, you can have it barred by your authorised BMW Motorrad dealer.

If you wish to do this, you will need to bring all other keys for the motorcycle with you. The engine cannot be started by a barred key, but a key that has

been barred can subsequently be reactivated.

You can obtain extra keys only through an authorised BMW Motorrad dealer. The keys are part of an integrated security system, so the dealer is under an obligation to check the legitimacy of all applications for replacement/extra keys.

Ignition with Keyless Ride

- with Keyless Ride^{OE}

Keys



NOTICE

The telltale light for the radio-operated key flashes while the search for the radio-operated key is in progress.

The telltale light goes out as soon as the radio-operated key or the emergency key is found.

The telltale light goes out briefly if the search times out without the radio-operated key or the emergency key being found.◀

You receive one radio-operated key and one emergency key. Please consult the information on the electronic immobiliser (EWS) if a key is lost or mislaid (► 56). Ignition, fuel filler cap and anti-theft alarm system all work with the radio-operated key. Seat lock, stowage compartment, topcase and cases can be locked and unlocked manually.



NOTICE

The vehicle cannot be started or the central locking system locked or unlocked if the radio-operated key is not within range (e.g. key inside one of the cases or the topcase).

If the key is taken out of range the ignition is switched off after

approximately 1.5 minutes, but the central locking system is **not** locked.

It is advisable to keep the radio-operated key on your person (e.g. in a jacket pocket) and to have the emergency key with you as an alternative.◀



Range of the Keyless Ride radio-operated key

approx. 1 m

Lock the handlebars

Requirement

The handlebars are turned towards the left. Radio-operated key is within range.



- Press and hold down button **1**.
 - » The steering lock engages with an audible click.
 - » Ignition, lights and all function circuits switched off.
- Briefly press the **1** button to unlock the steering lock.

Switching on ignition

Requirement

Radio-operated key is within range.



- There are **two** ways of activating the ignition.

Version 1:

- Briefly press button **1**.
 - » Side lights and all function circuits are switched on.
 - with daytime riding light^{OE}
 - with Headlight Pro^{OE}
 - » Daytime riding light is switched on.◁
 - with additional headlight^{OE}
 - » LED auxiliary headlights are switched on.◁
 - » Pre-Ride-Check is performed. (▣▣▣ 121)

- » ABS self-diagnosis is in progress. (▣▣▣ 122)
- » ASC self-diagnosis is performed. (▣▣▣ 123)
 - with riding modes Pro^{OE}
- » DTC self-diagnosis is in progress. (▣▣▣ 123)◁

Version 2:

- Steering lock is engaged; press and hold down button **1**.
 - » The steering lock disengages.
 - » Parking lights and all function circuits switched on.
 - » Pre-Ride-Check is performed. (▣▣▣ 121)
 - » ABS self-diagnosis is in progress. (▣▣▣ 122)
 - » ASC self-diagnosis is performed. (▣▣▣ 123)
 - with riding modes Pro^{OE}
 - » DTC self-diagnosis is in progress. (▣▣▣ 123)◁

Switching off ignition Requirement

Radio-operated key is within range.



- There are **two** ways of deactivating the ignition.

Version 1:

- Short-press button **1**.
 - » Light is switched off.
 - » Handlebars (steering lock) are not locked.

Version 2:

- Turn the handlebars all the way to left.

- Press and hold down button **1**.
- » Light is switched off.
- » The steering lock engages.

Switching engine run-on circuit on and off

NOTICE

See the section entitled "Engineering details" for more information on the engine run-on circuit.◀

- Fold out side stand with the engine running at idle to switch the function on.
- Remove radio-operated key from the vehicle.
- » The engine continues running and charges the battery.
- » The motorcycle is secured.
- Bring the radio-operated key into frequency range and fold the side stand in to switch the function off.

NOTICE

There may be a delay before the key is detected. As long as the key symbol is displayed in the multifunction display and driving off is not possible.◀

- » The vehicle can be ridden.

Electronic immobiliser EWS

The on-board electronics access the data saved in the radio-operated key via a ring aerial in the R/C ignition lock. The ignition is not enabled for starting until the engine control unit has recognised the radio-operated key as "authorised" for your motorcycle.

NOTICE

A spare key attached to the same ring as the radio-operated key used to start the engine could impair the electronics

function, in which case the enabling signal for starting is not issued. The warning is displayed on the multifunction display with the key symbol.

Always keep the spare key separate from the radio-operated key.◀

If you mislay a radio-operated key you can have the key in question barred by your authorised BMW Motorrad dealer. In order to have a key barred you must bring along all the other keys belonging to the motorcycle.

The engine cannot be started by a barred radio-operated key, but a radio-operated key that has been barred can subsequently be reactivated.

You can obtain emergency/extra keys only through an authorised BMW Motorrad dealer. The radio-operated keys are part of an integrated security system, so

the dealer is under an obligation to check the legitimacy of all applications for replacement/extra keys.

Loss of the radio-operated key, emergency key is available

Requirement

Emergency key is available.

- Place the motorcycle on its stand on firm, even ground.
- Please consult the information on the electronic immobiliser (EWS) if a key is lost or mislaid.
- If you happen to lose the radio-operated key during the journey, you can start the vehicle using the emergency key.

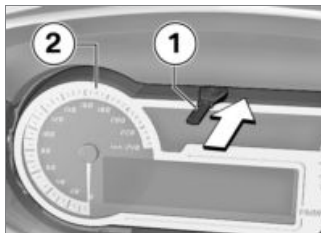

- Insert the emergency key **1** in the gap **in the centre** above the instrument cluster **2** (arrow).



Time during which the engine has to be started. The unlocking procedure has to be repeated if this time is allowed to expire.

30 s

- » Pre-ride check is performed.
- Key has been recognised.
- Engine can be started.
- Start engine (121).

Battery of the radio-operated key is empty, emergency key is not available

- Place the motorcycle on its stand on firm, even ground.

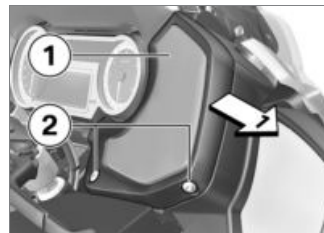

- Remove screws **2**.
- Ease speaker cover **1** to the right to remove.

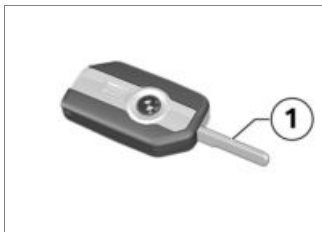

- Flip open the key bit.
- Hold the radio-operated key by the key bit **1**.

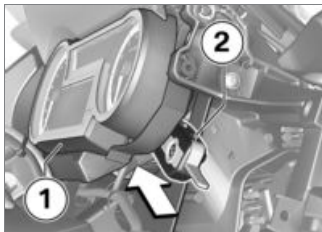

- Hold the radio-operated key **to the rear** of the instrument

cluster **1 (arrow)**, level with the warning and indicator lights.

 Time during which the engine has to be started. The unlocking procedure has to be repeated if this time is allowed to expire.

30 s

- » Pre-ride check is performed.
 - Key has been recognised.
 - Engine can be started.
- Start engine (►► 121).

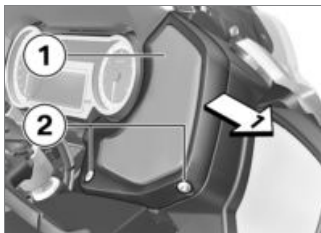

- Hold speaker cover **1** in position and install screws **2**.

Replace the battery of the radio-operated key

If the radio-operated key does not react when you short-press or long-press a button:

- The battery in the radio-operated key is not at full capacity.
- » Change the battery.

 The battery symbol appears on the display.

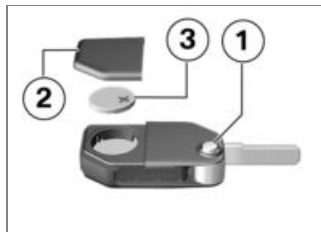

- Press button **1**.
- » Bitted key flips out.
- Push up battery cover **2**.
- Remove battery **3**.

- Dispose of the old battery in accordance with all applicable laws and regulations; do not attempt to dispose of batteries as domestic waste.



ATTENTION

Unsuitable or incorrectly inserted batteries

Component damage

- Use a battery compliant with the manufacturer's specifications.
- When inserting the battery, always make sure polarity is correct. ◀
- Insert the new battery with the positive terminal up.



Battery type

For Keyless Ride radio-operated key

CR 2032

- Install seal **1** and battery cover **2**.
- » Red LED on the instrument panel flashes.
- » The radio-operated key is again ready for use.

Emergency off switch (kill switch)



- 1** Emergency off switch (kill switch)



WARNING

Operation of the kill switch while riding

Risk of fall due to rear wheel locking

- Do not operate the kill switch when riding. ◀

The emergency off switch is a kill switch for switching off the engine quickly and easily.

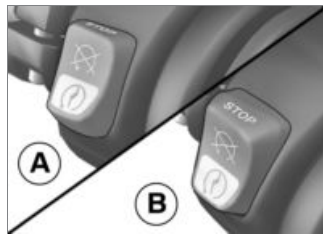

- A** Engine switched off
B Normal operating position (run)

Lights

Side light

The side lights switch on automatically when the ignition is switched on.

NOTICE

The side lights place a strain on the battery. Do not switch the ignition on for longer than absolutely necessary. ◀

Low-beam headlight

The low-beam headlight switches on automatically when you start the engine.

High-beam headlight and headlight flasher



- Push switch **1** forward to switch on the high-beam headlight.
- Pull switch **1** back to operate the headlight flasher.

NOTICE

The high-beam headlight can also be switched on when the engine is not running. ◀

Headlight courtesy delay feature

- Switch off the ignition.



- Immediately after having switched off the ignition, pull the switch **1** towards the rear and hold it until the delayed headlight switch-off has switched on.
 - » The vehicle lights light up for one minute before they are automatically switched off.
- For instance, use this feature to light up the way to the front door after having parked the vehicle.

Parking lights

- Switch off the ignition.

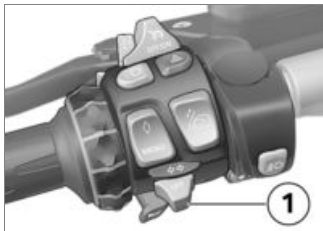

- Immediately after switching off the ignition, push button **1** to the left and hold it in this position until the parking lights come on.
- Switch the ignition on and off again to switch off the parking lights.

Surround lighting

– with LED 360° marker strobe^{OE}

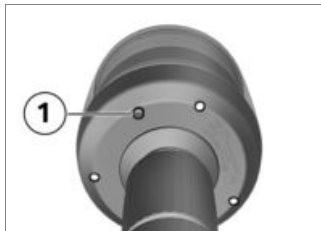

- Make sure the ground is level and firm and place the motorcycle on its centre stand.



NOTICE

The surround lighting is not approved for road use. Always comply with the road traffic regulations in force in the country in which the vehicle is used.◀

- Switch off the ignition.



NOTICE

The surround lighting can be switched on within the after-run-

ning period after the ignition has been switched off.◀

- Press the button **1** on the underside of the 360° marker strobe.



WARNING

Riding with the 360° marker strobe extended.

Risk of accident

- Do not ride the motorcycle with the 360° marker strobe extended.◀
- If necessary, expand the light beam by pulling out the LED on the 360° marker strobe.
 - » The surround lighting switches off automatically when riding off.

LED auxiliary headlights

– with additional headlight^{OE}

Requirement

The additional headlights are only active if the low-beam headlight is active; if the daytime riding light is switched on, it is not possible to switch on the additional headlights.



NOTICE

The auxiliary headlights have approval as fog lights and their use is permissible in bad weather conditions only. Always comply with the road traffic regulations in force in the country in which the vehicle is used. ◀



- Press the bottom section of button **1** to switch on the LED auxiliary headlights.
- Press the button again to switch off the LED auxiliary headlights.

Cruising Light

– with cruising light^{OE}

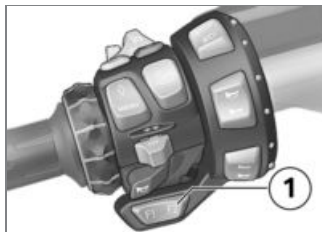

Press button **1** (F2) to switch on the Cruising Light. The LED 360° marker strobe and the LED marker strobes are dimmed.



NOTICE

The Cruising Light puts a load on the battery. Switch on the ignition for a limited time only. ◀

Switching off Cruising Light

– with cruising light^{OE}

Requirement

Ignition is switched on.



- Press button **1**.
 - » Dimming is cancelled.
 - » The LED 360° marker strobe and the LED marker strobes show at full brightness.
- Press the function button for Cruising Light to switch off the Cruising Light (only if function is coded accordingly).



NOTICE

Depending on the equipment and customer request, the function keys F1 to F4 can be assigned special functions (see Technical Data).◀

Day run lights

Manual daytime riding light

– with daytime riding light^{OE}

Requirement

Automatic daytime riding light is switched off.



WARNING

Switching on the daytime riding light in the dark.

Risk of accident

- Do not use the daytime riding light in the dark.◀



NOTICE

By comparison with the low-beam headlight, the daytime running light makes the vehicle more visible to oncoming traffic. This improves daytime visibility.◀

- Start engine (→ 121).
- Call up the **Settings** menu and then select **Vehicle**.
- Select the **DRL** menu item and switch **Automatic DRL** to **Off**.



- Press button **1** to switch on the daytime riding light.



The indicator light for the daytime running light illuminates.

- » The low-beam headlight, the front side lights and the auxiliary headlight are switched off.
- In the dark or in tunnels: Press button **1** again to switch off the daytime riding light and switch on the low-beam headlight and front side light. The auxiliary headlight is also switched on again.



NOTICE

The daytime riding light is switched off after approximately 2 seconds and the high-beam headlight, low-beam headlight, front side lights and the additional headlight, as appropriate, are switched on if the high beam is switched on while the daytime riding light is on.

If the high beam headlight is switched off again, the daytime running light is not automatically reactivated, but must be switched on again if required. ◀

Automatic daytime riding light

– with daytime riding light^{OE}



WARNING

The automatic daytime riding light does not replace the personal assessment of the light conditions

Risk of accident

- Switch off the automatic daytime riding light in poor light conditions. ◀



NOTICE

The changeover between daytime riding light and low-beam headlight including front

side lights can be effected automatically. ◀

- Call up the **Settings** menu and then select **Vehicle**.
- Select the **DRL** menu item and switch **Automatic DRL** to **On**.



The symbol for the automatic daytime running light shows in the display.

- » If the ambient brightness decreases below a certain value, the low beam headlight is automatically switched on (e. B. in a tunnel). When sufficient ambient brightness is detected, the daytime riding light is switched back on. When the daytime riding light is active, the daytime riding light symbol is displayed in the multifunction display.

Manual operation of the light when the automatic system is switched on

– with daytime riding light^{OE}

- If you press the button for the daytime riding light the daytime riding light is switched off and the low-beam headlight and front side lights are switched on (e. g. when you ride into a tunnel, and the response of the automatic daytime riding light to the change in ambient brightness is delayed).
- If you press the button again the daytime riding light is re-activated, in other words the daytime riding light is switched on again when ambient light is bright enough.

Operate the rear fog light

– with rear fog light^{OE}



- Press the top section of button **1** to switch on the rear fog light.
 - » How to interpret the indicator light:
 - Yellow status-indicator light ON: Rear fog light is switched on
- Press the button again to switch off the rear fog light.

Hazard warning lights system

Operating hazard warning flashers

- Switching on ignition (➡ 54).



NOTICE

The hazard warning flashers place a strain on the battery. Do not use the hazard warning flashers for longer than absolutely necessary. ◀



- Press button **1** to switch on the hazard warning flashers.

- » Ignition can be switched off.
- To switch off the hazard warning flashers, switch on the ignition if necessary and press button **1** again.

Turn indicators

Operating the turn indicators

- Switch on the ignition.

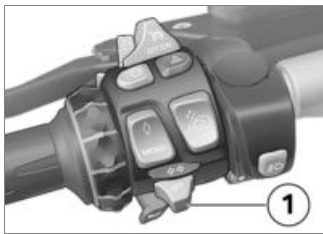

- Press button **1** to the left to switch on the left turn indicator.
- Press button **1** to the right to switch on the right turn indicator.

- Operate button **1** in the centre position to switch off the turn indicator.

Comfort turn indicator

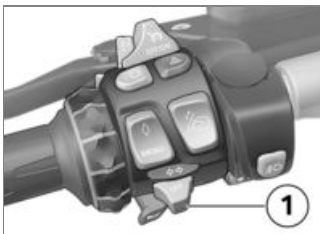

If button **1** has been pressed to the right or left, the turn indicators are automatically switched off under the following circumstances:

- Speed below 30 km/h: after 50 m distance covered.
- Speed between 30 km/h and 100 km/h: after a speed-dependent distance covered or in case of acceleration.

- Speed over 100 km/h: after flashing five times.

If button **1** is pressed to the right or left slightly longer, the turn indicators only switch off automatically once the speed-dependent distance covered is reached.

Light signals

Front LED flashing warning light

- with LED flashing warning light^{OE}



- Switch on the ignition.

NOTICE

The front LED marker strobes place a load on the second battery. Switch on LED marker strobes for a limited time period only.◀

- Press upper section of button **1** to switch on the front LED flashing warning lights.
 - » How to interpret the indicator light:
 - Blue indicator light illuminated: LED flashing warning lights are on
 - Blue indicator light flashing: fault detected with LED flashing warning lights
 - with LED flashing warning light, blue/yellow^{OE}
- Press and hold button **1** to switch on the secondary colour.<

- Press button again to switch off the front LED flashing warning lights.

NOTICE

For the front LED flashing warning lights, an after-running period can be set after the ignition is switched off.

In the default setting, the front LED flashing warning lights remain on for 30 minutes. Your authorised BMW Motorrad Retailer can encode the after-running period to different values (30 or 60 minutes).◀

NOTICE

Your authorised BMW Motorrad Retailer can encode the special functions. Special functions, see Technical Data.◀

- Observe the instructions on the use of the alternating frontal light.

Switching on alternating frontal light

Requirement

The alternating frontal light is coded by your BMW Motorrad retailer.



- Switch on the ignition.
- Press upper section of button **1** up to switch on the LED flashing warning lights.

NOTICE

The flashing frequency of the alternating frontal light can be set by your authorised BMW Motorrad Retailer to 1 Hz, 1.5 Hz or 2 Hz. ◀

NOTICE

Your authorised BMW Motorrad Retailer can encode the special functions.

Special functions, see Technical Data. ◀

- » The high beam and the additional headlight light in an alternating pattern in addition to the LED flashing warning light.
- » If the ambient brightness decreases below a certain value, the alternating frontal light is automatically switched off (e. g. in a tunnel). When sufficient ambient brightness is detected,

the alternating frontal light is switched back on.

Deactivating the alternating frontal light Requirement

The deactivation option of the alternating frontal light is encoded by your authorised BMW Motorrad Retailer. Your vehicle has a multifunction switch on the right with the button **1**.



- Hold down the button **1** at the bottom to deactivate the alternating frontal light.

NOTICE

Your authorised BMW Motorrad Retailer can adjust the switch-off function of the alternating frontal light. Either the last setting is saved permanently or it is reset by switching off the ignition. ◀

- » Meaning of the indicator light:
 - Green indicator light pulsates slowly: alternating frontal light is deactivated.
- To reactivate the alternating frontal light, hold down the button **1** at the bottom again.

Using the 360° marker strobe

- with LED 360° marker strobe^{OE}



- Switch on the ignition.



NOTICE

The 360° marker strobe places a load on the second battery. Switch on 360° marker strobe for a limited time period only. ◀



WARNING

Riding with the 360° marker strobe extended.

Risk of accident

- Do not ride the motorcycle with the 360° marker strobe extended. ◀

- Press lower section of button **1** to switch on the 360° marker strobe.

– with LED flashing warning light, blue/yellow^{OE}

- Press and hold button **1** to change the colour.

» The 360° marker strobe lights up in the desired colour.

» If the motorcycle is fitted with two rear warning lights:

– Both rear warning lights are switched together with button **1**.

» How to interpret the indicator light:

– Blue indicator light illuminated: 360° marker strobe light is switched on

– Blue indicator light flashing: fault detected with 360° marker strobe ◀

- Press button again to switch off the 360° marker strobe.



NOTICE

Your authorised BMW Motorrad Retailer can encode the special functions.

Special functions, see Technical Data. ◀

» The blue indicator light goes out.

Front stop signal

- with STOP signal, front^{OE}
- or
- with STOP matrix sign and YELP sound^{OE}

Requirement

Decide which of the 2 preset stop signals is to be turned on: e.g. front signal 1 "STOP POLICE" or e.g. front signal 2 "ATTENTION".

NOTICE

The displayed text may be different. ◀

NOTICE

Your authorised BMW Motorrad Retailer can encode the displayed text. ◀

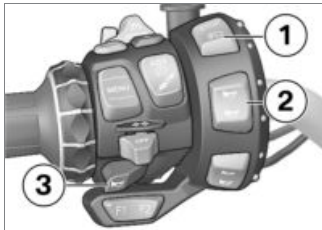

- Briefly press button **1** to switch on front signal 1 "STOP POLICE".
- » The stop signal flashes on the front STOP signal.

- » The red indicator light for button **1** lights up.
- Hold down button **1** to switch on front signal 2 "ATTENTION".
- » The red indicator light for button **1** flashes with a slow rhythm.

– with STOP matrix sign and YELP sound^{OE}

- To activate the flashing of the stop signal ("STOP flash"), press button **2** at the top.
- To activate the emergency power siren "yelp", press button **3**.

NOTICE

The yelp siren signal is specified only in Germany and can only be used when the marker strobe is switched on. ◀◀

- Press button **1** again to switch off the stop signal.

- » Meaning of the indicator light:
 - Indicator light flashes slowly if the STOP signal has detected a fault.

Rear stop signal

– with STOP signal^{OE}

Requirement

Decide which of the four pre-set stop signals is to be turned on: rear signal 1 (e.g. "PLEASE FOLLOW"), rear signal 2 (e.g. "EMERGENCY CORRIDOR"), rear signal 3 (e.g. "STOP POLICE") or rear signal 4 (e.g. "ACCIDENT >>>>").

NOTICE

The displayed text may be different. ◀

 **NOTICE**

Your authorised BMW Motorrad Retailer can encode the displayed text. ◀



- Press button **1** at top to switch on rear signal 1.
- » The red indicator light for button **1** flashes at the top in the slow rhythm of the stop signal.
- Press button **1** at bottom to switch on rear signal 2.
- » The red indicator light for button **1** lights up at the bottom.
- Hold pressed button **1** at top to switch on rear signal 3.

- » The red indicator light for button **1** lights up at the bottom.
- Hold pressed button **1** at bottom to switch on rear signal 4.
- » The red indicator light for button **1** lights up at the bottom.
- Press button **1** again to switch off the stop signal.

Encoding of the stop signals

- with STOP signal^{OE}

The front/rear stop signals can be encoded depending on the equipment and customer request. To change the encoding, consult a specialist workshop, preferably a BMW Motorrad partner.

The following stop signals are encoded in the factory settings:

- Front signal 1: STOP POLICE
- Front signal 2: ATTENTION

- Rear signal 1: PLEASE FOLLOW
- Rear signal 2: EMERGENCY CORRIDOR
- Rear signal 3: STOP POLICE
- Rear signal 4: ACCIDENT
- >>>>

Amongst others, the following stop signals can be selected for the encoding:

- CUSTOMS CONTROL
- HEAVY TRANSPORT
- POLICE PLEASE FOLLOW
- ROADBLOCK
- NO OVER TAKING

For a complete list of all encodable stop signals, please contact a specialist workshop, preferably a BMW Motorrad partner.

Lights-off setting

– with light deactivation^{OE}

WARNING

Insufficient visibility for other road users

Risk of accident

- Exercise caution when using the "lights off" function.
- Comply with the statutory regulations. ◀



- Press the bottom section of button **1** to activate the lights-off setting.

NOTICE

LED flashing warning lights, 360° marker strobe, LED additional headlight and rear fog light must be switched off separately. ◀

- » Dipped beam, side lights and tail light are switched off.
- » How to interpret the indicator light:
 - Green status-indicator light ON: Lights-off setting is active
 - Press the button again to deactivate the lights-off setting.

Sound signals

Hailing system

– with hailing system, electronic^{OE}



- Press top section of switch **1** to set the hailing system to standby mode.
 - » The hailing system sounds one complete hailing cycle when horn button **2** is pressed.
- Press bottom section of switch **1** to activate the hailing system in constant-operation mode.
- Centre the switch **1** to switch the hailing system off.

NOTICE

The "hailing system" function is not available unless the marker light has been activated. ◀

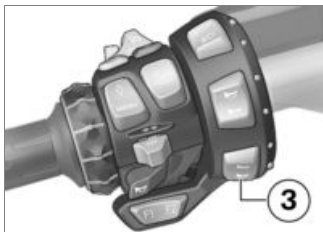

- Press switch **3** to select the type of hailing-system signal, for example day and night signal or city and countryside signal.

NOTICE

The type of sound signal is country dependent and can be

encoded by your authorised BMW Motorrad Retailer. Country relevant encoding of the sound signals, see Technical Data. ◀

NOTICE

Different country sounds and siren sounds are adjustable. The replacement parts are available at your authorised BMW Motorrad Retailer. ◀

NOTICE

Your authorised BMW Motorrad Retailer can encode the special functions. Special functions, see Technical Data. ◀

Siren

– with siren, electronic^{OE}



- Press top section of switch **1** to activate the siren in yelp mode.
- Press bottom section of switch **1** to activate the siren in wail mode.
- When the siren is active, press the horn button **2** to toggle from one siren operating mode to the next.
- Centre the switch **1** to switch the siren off.

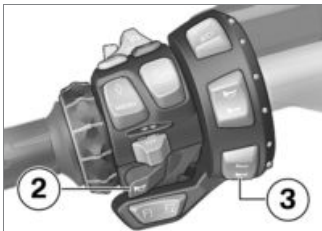

- Press top section of switch **3** to set the siren to "hold & peak" for activation when the horn button **2** is pressed.
- Press bottom section of switch **3** to set the siren to "airhorn" for activation when horn button **2** is pressed.



NOTICE

The siren signals "hold & peak", "airhorn" and "hilo" have a higher priority than "wail/yelp".◀

» The siren sounds in the corresponding mode for as long as horn button **2** is pressed down.

– If the vehicle has country-specific coding for US siren (one-button operation), press **F3**.

Microphone

– with intercom system^{OE}

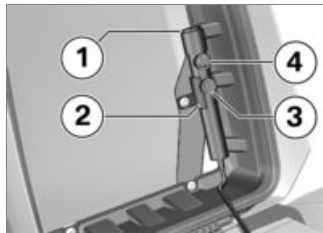

– with single seat with radio transceiver box^{OE}

- Open radio transceiver box (▶ 195).
- Remove microphone **1** from holder **2**.
- Press talk button **3**.

» Voice announcement can be made over the public-address system.

- Adjust the volume at potentiometer **4**. Turn the potentiometer, taking care not to cause audio feedback.
- Release talk button **3** when you pause.
- After making the announcement, replace microphone **1** in holder **2**.
- Closing radio transceiver box (▶▶ 184).

Multifunction display

Selecting menu

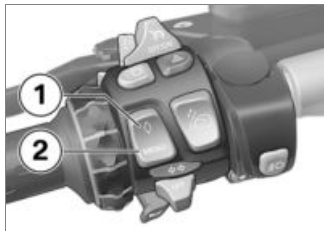

Press button **2** to step through the sequence of menus, starting with the *Dynamic ESA* menu. Each time you press button **2** you call up the next menu in the sequence; the number of menus depends on the options fitted to the motorcycle.

You also have the option of pressing button **1** for direct access to a favourite menu of your choice.

With the exception of the "Two-way radio" section, you cannot access the *Settings* menu unless the motorcycle is at a complete standstill.

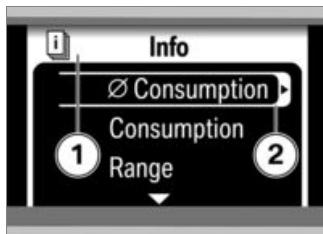

The menu you selected appears at position **1**. The submenu you selected **2** has a border.



NOTICE

See the separate Quick Reference Guide for an overview of all menus.◀

Selecting menu item

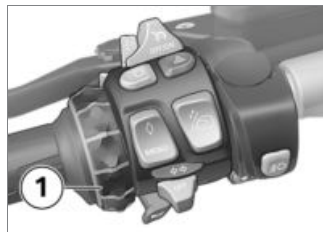

Use Multi-Controller **1** to move the cursor in a menu.

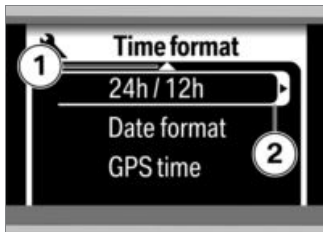

An arrow **1** at the top or bottom of the display indicates that there are other items in this menu that you can view by turning the Multi-Controller in the corresponding direction. If arrow **2** appears in the cursor, you can call up a submenu by pressing the Multi-Controller to the right (for information on the different meaning in relation to average values and list selections, see (→ 79)).

Setting parameters

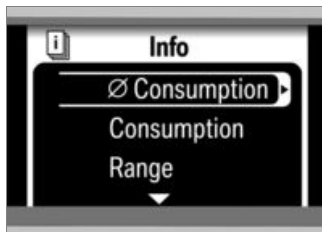

Direct selection

If you move the cursor to a menu item that requires no other settings, your selection goes active right away.

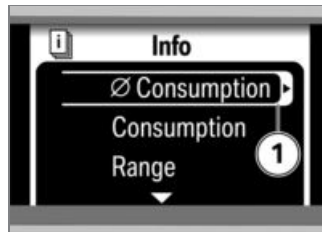

Resetting values

You can reset average values marked with an arrow **1** by long-pressing the Multi-Controller to the right.



Selecting from a list

A circle **1** beside each selectable item means that the items are part of a selection list. A circle with a dot indicates the item that is currently selected.

If you want to change the selection move the cursor to some other item in the list and press the Multi-Controller to the right to either activate or deactivate the parameter you selected.

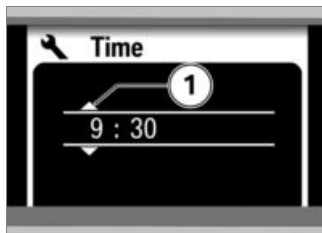

Setting numerical values

If there are one or more numerical values between the arrows **1**, you can increase the values by turning the Multi-Controller up or reduce the values by turning it down. You can toggle between the values by pressing the Multi-Controller to the right or left.

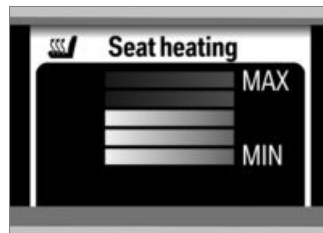

Setting relative values

A bar indicator enables you to set a value in a range between two limits. Turn the Multi-Controller up to increase the setting or down to reduce the setting.

Exiting menu



Arrow **1** appears when you are in a submenu.

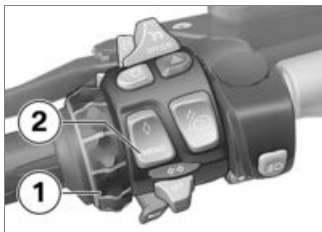

Press Multi-Controller **1** to the left to return to the next highest menu; press **MENU** button **2** to return to the main menu.

If you want to hide the menus, press Multi-Controller **1** to the left in a main menu.

Selecting favourite menu

- Select the main menu of your choice.



- Press and hold down button **1**.
 The lozenge appears to the right of the selected menu.

» The menu you have selected will subsequently be called up whenever you press button **1**.

Adapting mode of presentation

- Switch on the ignition.
- Call up the **Settings** menu and select the **User** menu item.

The settings you can choose are as follows:

- Language: display language (German, English, Spanish, Italian, French, Dutch, Portuguese)
- Time format - Clock format: time in 12 hour format (12 h) or 24 hour format (24 h)
- Time format - Date format: date in Day.Month.Year format (dd.mm.yy) or Month/Day/Year format (mm/dd/yy)
- Time format - GPS time: transfers GPS time and GPS date from the installed navigation system (On), (Off)
- Brightness: display and needle brightness
- Start logo: displays the start logo after switching on the ignition (On), (Off)
- Default status: restore factory default settings (if Reset! is displayed, press and hold the Multi-Controller towards the right)

- Background: displayed if the radio is switched off: Empty: off, Logo: logo (RT), Speed ind.: digital speed.
- Use the Multi-Controller to configure the desired settings.

On-board computer

Select display

- Call up the Information menu and then select the desired information.



The following information can be displayed in the area 1:

- Ø consumption: Average consumption
- Consumption: Current consumption
- Range: Range with remaining fuel
- Ø speed: Average speed
- Temperature: Ambient temperature
- Tyre pressure: Tyre inflation pressures
- Stopwatch: Stopwatch
- Trav. times: Travelling times
- Date: Current date
- Oil level: Engine oil level
- Veh. voltage: Vehicle voltage
- Off: No display

Resetting the average values

- Call up the Information menu and then select the av-

average value you would like to reset.

- Push the Multi-Controller to the right and hold it in this position until the average value is reset.

Operate stopwatch

- Call up the **Information** menu and then select the **Stopwatch** menu item.

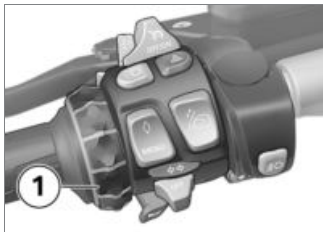

- With the stopwatch stopped, push Multi-Controller **1** to the right to start the stopwatch.
 - » The stopwatch continues timing even if you select some

other reading or switch off the ignition.

- When the stopwatch is running, push Multi-Controller **1** to the right to stop the stopwatch.
- Push Multi-Controller **1** to the right and hold it in this position to reset the stopwatch.

Measuring travel times

- Call up the **Information** menu and then select the **Trav. times** menu item.

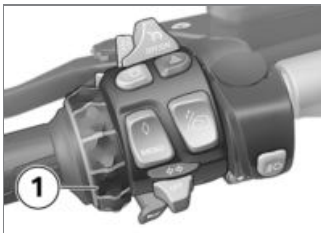

- Push Multi-Controller **1** to the right and hold it in this position to reset the travel time.

» Timing continues even if you select some other reading or switch off the ignition.

 Time during which the motorcycle was on the move since the last reset.

 Time during which the motorcycle was at a standstill since the last reset.

Authorities speed indicator

– with km/h instrument cluster for special vehicle^{OE}

Saving road speed



- Short-press the right section of button **1** (F4) to save the true speed once only.



NOTICE

Depending on the equipment and customer request, the function keys F1 to F4 can be assigned special functions (see Technical Data). ◀

 Minimum speed for activation of the authority-vehicle speedometer

min 5 km/h

- Long-press the right section of button **1** to save the true speed cyclically.

 Interval for cyclic recording

0.5 s



The last speed saved **2** is shown.

- To end cyclic recording, release button **1** or bring the motorcycle to a standstill.

Trip recorder

Select trip recorder

- Switch on the ignition.

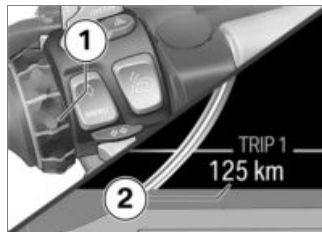

- Go to Trip menu with Multi-Controller **1**, then select the desired trip recorder **2**.

The following counters can be displayed:

- Trip recorder 1 (Trip 1)
- Trip recorder 2 (Trip 2)

- The automatic trip recorder (Trip Auto.) automatically resets eight hours after the ignition is switched off.

Reset trip recorder

- Switch on the ignition.
- Select desired trip recorder.

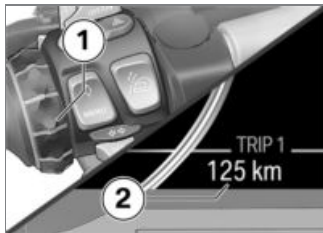

- Keep Multi-Controller **1** pressed to the right until the trip recorder **2** has been reset.

Antilock Brake System (ABS)

- with US authority^{OE}

ABS Switching off

- Switching on ignition (➡ 54).
- Removing front seat (➡ 100).
- Insert ABS fuse until the ABS warning light shows.
- Remove the ABS fuse.

 ABS indicator and warning light shows.

- » ABS is switched off.
- Installing front seat (➡ 100).

ABS Switching on

- Switching off ignition (➡ 55).
- Switching on ignition (➡ 54).

NOTICE

An ABS fault has occurred if the ABS telltale and warning light shows when the motorcycle accelerates to a speed in excess

of 3 mph (5 km/h) after the ignition was switched off and then on again.◀

» ABS is switched on.

Automatic Stability Control (ASC)

Switching ASC function off and on

- Switch on the ignition.
- Call up the Settings menu and then select the ASC menu item.

NOTICE

This menu cannot be called up while the motorcycle is on the move.◀

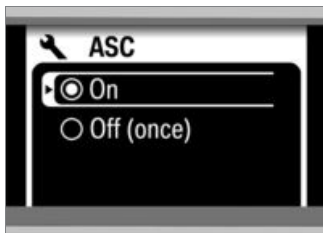

- Select **Off (once)** to switch off ASC once and reactivate it when the ignition is switched on the next time.

 lights up.

- Select **On** to switch on the ASC. Alternatively: switch the ignition off and then on.

 goes out, if self-diagnosis has not completed the ASC indicator and warning light starts flashing.

Dynamic Traction Control (DTC)

– with riding modes Pro^{OE}

Switching the DTC function off/on

- Switch on the ignition.
- Open the **Settings** menu and then select the **DTC** menu item.



NOTICE

This menu cannot be called up while the motorcycle is on the move. ◀

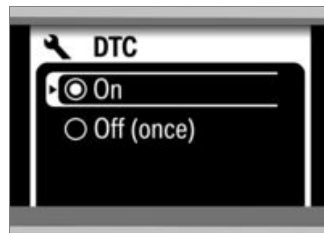

- Select **Off (once)** to switch off DTC once until the next time you switch on the ignition.

 lights up.

- Select **On** to switch on DTC. Alternatively: switch the ignition off and then on.

 goes out, if self-diagnosis has not completed the DTC indicator and warning light starts flashing.

Electronic Suspension Adjustment (D-ESA)

- with Dynamic ESA^{OE}

Dynamic ESA possible settings

The electronic chassis and suspension setting Dynamic ESA is able to adjust your motorcycle automatically to the load. If the spring setting is set to **AUTO**, the rider does not have to change the load setting.

See the "Engineering details" section for more information on Dynamic ESA (➡ 142).

Available damping modes

- For comfortable on-road riding: **ROAD**
- For dynamic on-road riding: **DYNA**

Available load settings

- Predefined minimum spring setting: **MIN**
- Active riding position equaliser with automatic spring setting: **AUTO**
- Predefined maximum spring setting: **MAX**

Adjusting the chassis and suspension

- Start the engine.

NOTICE

You can adjust the damping characteristic while the motorcycle is on the move.◀

- Call up the **Dynamic ESA** menu.

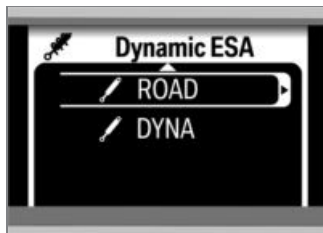

The possible damping settings are displayed.

- **ROAD**: Damping for comfortable on-road riding.
- **DYNA**: Damping for dynamic on-road riding.
- Select the damping characteristic you want or move the cursor down to set the vehicle load.

NOTICE

The load cannot be set while the motorcycle is in motion.◀

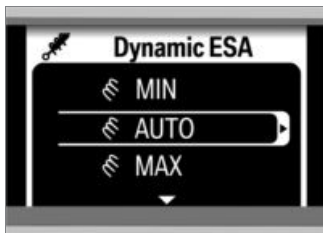

The possible load settings are displayed.

- MIN: Minimum spring setting
- AUTO: Automatic spring setting
- MAX: Maximum spring setting
- Select the desired loading variant.
- » The chassis and suspension is adjusted as per the selection and the Dynamic ESA display is adapted to the new setting. Symbols for load and damping action are shown in grey during the adjustment procedure.

Riding mode

Using the riding modes

BMW Motorrad has developed 3 operational scenarios for your motorcycle from which you can select the scenario suitable for your situation:

- Riding on a rain-wet roadway.
- Riding on a dry roadway.
- with riding modes Pro^{OE}
- Dynamic riding on a dry road surface.

The relevant optimum interplay of throttle response and ASC/DTC control is provided for each of these three scenarios.

- with Dynamic ESA^{OE}

The chassis and suspension setting also adjusts to the chosen scenarios.

Setting riding mode

- Switching on ignition (➡ 54).



- Press button **1**.

NOTICE

See the section entitled "Engineering details" for more information on the various ride modes that can be selected.◀

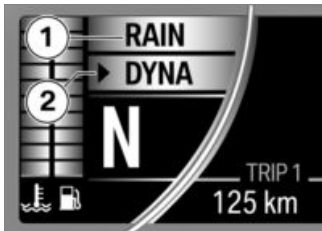

The selection arrow **2** and the active riding mode **1** are displayed.



- Press button **1** repeatedly until the required riding mode is

indicated next to the selection arrow.

The following ride modes can be selected:

- RAIN: For riding on a rain-wet road.
- ROAD: For riding on a dry road.

– with riding modes Pro^{OE}

» The following riding mode can also be selected:

- DYN: For dynamic riding on a dry road.◀

» With the motorcycle at a standstill, the selected mode is activated after approximately two seconds.

» The newly selected riding mode is activated as you ride only when the following preconditions are satisfied:

- Throttle grip is in the idle position.
- Brake is not applied.
- Cruise control is not active.

» After activating the new riding mode, the symbols for coolant temperature and fuel level are displayed again.

» The adjusted riding mode with the associated adaptations of ASC/DTC and Dynamic ESA remain available even after having switched off the ignition.

Cruise-control system

- with cruise control^{OE}

Switching on cruise control

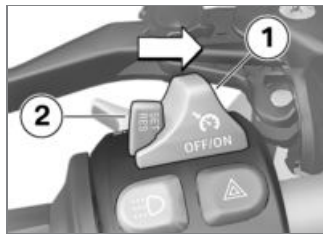

- Slide switch **1** to the right.

» Button **2** is enabled for operation.

Saving road speed



- Briefly push button **1** forward.

 Adjustment range for cruise control (gear-dependent)

10...210 km/h

SET Telltale light for cruise control shows.

» The motorcycle maintains your current cruising speed and the setting is saved.

Accelerating



- Briefly push button **1** forward.
 - » Speed is increased by approx. 1 km/h each time you push the button.
- Push button **1** forward and hold it in this position.
 - » The motorcycle accelerates with infinite variability (no steps).
 - » The current speed is maintained and saved if button **1** is not pushed again.

Decelerating

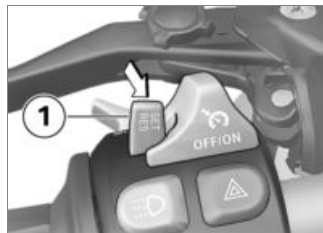

- Briefly push button **1** back.
 - » Speed is reduced by approx. 1 km/h each time you push the button.
- Push button **1** back and hold it in this position.
 - » The motorcycle decelerates with infinite variability (no steps).
 - » The current speed is maintained and saved if button **1** is not pushed again.

Deactivate cruise control

- Brake, pull the clutch lever or turn the throttle twistgrip (close the throttle by turning the twistgrip back past the idle position) to deactivate the cruise-control system.
 - » Telltale light for cruise control goes out.

Resuming former cruising speed



- Briefly push button **1** back to return to the speed saved beforehand.

NOTICE

Opening the throttle does not deactivate the cruise-control system. If you release the twistgrip the motorcycle will decelerate only to the cruising speed saved in memory, even though you might have intended slowing to a lower speed.◀

SET Telltale light for cruise control shows.

Switching off cruise control

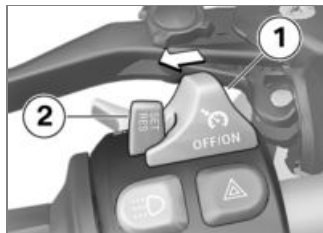

- Slide switch **1** to the left.
 - » The system is deactivated.
 - » Button **2** is disabled.

Hill Start Control

Operate Hill Start Control Requirement

The vehicle is at a standstill.

ATTENTION

Failure of the drive-off assistant

Risk of accident

- Secure the vehicle by braking manually.◀



NOTICE

Hill Start Control is purely a comfort system to facilitate holding the machine and pulling way on uphill gradients and should not be confused with a parking brake.◀



NOTICE

See the section entitled "Engineering details" for more information on Hill Start Control.◀

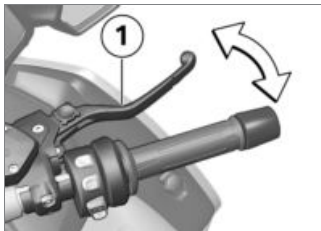

- Operate the brake lever **1** or footbrake lever strongly and release again quickly.



Green holding symbol is displayed.

- » Hill Start Control is activated.
- To switch off the Hill Start Control, operate the brake lever **1** or footbrake lever again.
-  The holding symbol disappears.
- Alternatively, ride off in 1st or 2nd gear.



NOTICE

When riding off, Hill Start Control is automatically deactivated.◀



Once the brake has been fully released, the holding symbol disappears.

- » Hill Start Control is deactivated.
- See the "Engineering details" section for more information on Hill Start Control.
- » Hill Start Control function (▶▶ 149)

Operating Hill Start Control Pro

– with riding modes Pro^{OE}

Requirement

Automatic Hill Start Control Pro switched on.

Switching automatic Hill Start Control Pro on and off

- with riding modes Pro^{OE}
- Switch on the ignition.
- Go to menu **Settings**, then select menu item **HSC AUTO**.

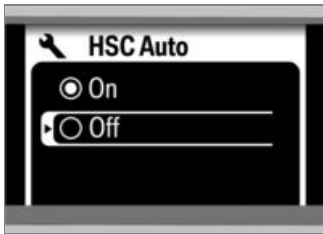

- To switch on automatic Hill Start Control Pro, select **On**.
-  White holding symbol is displayed.
- » If the brake is actuated for approximately one second after the vehicle has come to

a standstill and the motorcycle is on a gradient of at least 5%, Hill Start Control Pro is automatically activated.

- To switch off automatic Hill Start Control Pro, select **Off**.
 - » The selected setting remains stored even after the ignition is switched off.

Anti-theft alarm (DWA)

Activation without remote control or radio-operated key

– with anti-theft alarm (DWA)^{OE}

- If applicable, switch on automatic activation of the DWA anti-theft alarm after ignition OFF.
- DWA Adapting (▮▮▮ 97).
- Switch off the ignition.
 - » Activation takes 30 seconds to complete.
 - » Turn indicators flash twice.

- » Confirmation tone sounds twice (if programmed).
- » Anti-theft alarm (DWA) is switched on.

Activation with remote control or radio-operated key



NOTICE

Only vehicles without Keyless Ride are shipped accompanied by a separate remote control for the central locking system and the alarm system.◀

- Switch off the ignition.

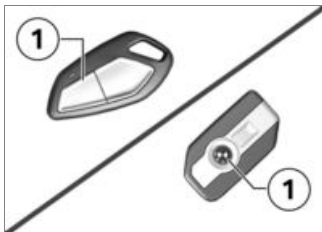

- Press button **1** on the remote control or the radio-operated key twice.



NOTICE

See also the other functions of the remote control for the central locking system. ◀

- » Activation takes 30 seconds to complete.
- » Turn indicators flash twice.
- » Confirmation tone sounds twice (if programmed).
- » Anti-theft alarm (DWA) is active.

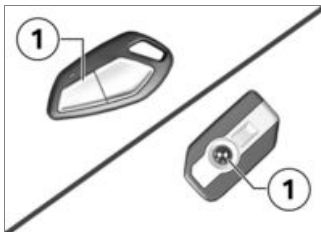

- To deactivate the motion sensor (for example if you are about to transport the motorcycle on a train and the swaying movement of the moving train could trip the alarm), press button **1** on the remote control or the radio-operated key again during the activation phase.
 - » Turn indicators flash three times.
 - » Confirmation tone sounds three times (if programmed).
 - » Motion sensor is deactivated.

Alarm signal

A DWA alarm can be triggered by:

- motion sensor
- an attempt to use an unauthorised vehicle key to switch on the ignition.
- disconnection of the DWA anti-theft alarm from the motorcycle's battery (DWA internal battery in the anti-theft alarm provides power - alarm tone only, the turn indicators do not flash)

All functions are sustained even if the internal battery of the DWA anti-theft alarm system is flat; the only difference is that an alarm cannot be triggered if the system is disconnected from the motorcycle's battery.

An alarm lasts for approximately 26 seconds. While an alarm is in progress an alarm tone sounds and the turn indicators flash. The type of alarm tone can be set by an authorised BMW Motorrad dealer.

If an alarm was triggered while the motorcycle was unattended, the rider is notified accordingly by an alarm tone sounding once when the ignition is switched on. The DWA LED then indicates the reason for the alarm for one minute.

Light signals issued by the DWA LED:

- Flashes 1x: Motion sensor 1
- Flashes 2x: Motion sensor 2
- Flashes 3x: Ignition switched on with unauthorised vehicle key
- Flashes 4x: Disconnection of the DWA anti-theft alarm from the motorcycle's battery

- Flashes 5x: Motion sensor 3
- with central locking system^{OE}
- or
- with Keyless Ride^{OE}

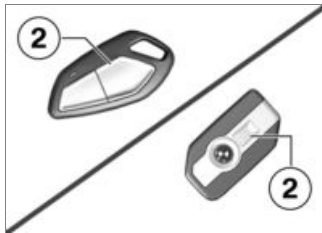

An activated alarm can be cancelled at any time by pressing button **2** of the remote control or radio-operated key without deactivating the DWA.

Deactivation without remote control or radio-operated key

- Kill switch in operating position (run).

- Switch on the ignition.
 - » Turn indicators flash once.
 - » Confirmation tone sounds once (if programmed).
 - » Anti-theft alarm (DWA) is deactivated.
- To deactivate the motion sensor (for example if you are about to transport the motorcycle on a train and the swaying movement of the moving train could trip the alarm), call up the `Settings` menu before switching off the ignition.
- Select `Vehicle - Alarm syst. - Sensor`.

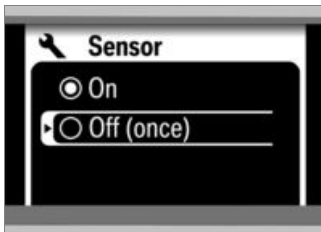

- Select *Off (once)* to switch off the motion sensor this once.
- Switch off the ignition.
 - » Activation takes 30 seconds to complete.
 - » Turn indicators flash three times.
 - » Confirmation tone sounds three times (if programmed).
 - » The anti-theft alarm (DWA) is active, the motion sensor is deactivated.

Deactivation with remote control or radio-operated key

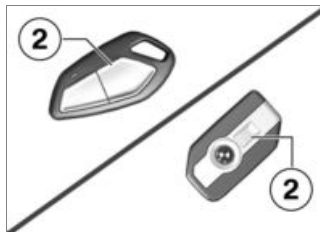

- Press button **2** on the remote control or the radio-operated key once.

NOTICE

See also the other functions of the remote control for the central locking system. ◀

NOTICE

The alarm function is reactivated after 30 seconds if "activation

after ignition off" has been selected if the alarm function is deactivated using the radio-operated key and the ignition is not then switched on. ◀

- » Turn indicators flash once.
- » Confirmation tone sounds once (if programmed).
- » Anti-theft alarm (DWA) is deactivated.

DWA Adapting

– with anti-theft alarm (DWA)^{OE}

- Call up the *Settings* menu and select the *Vehicle - Alarm system* menu item.

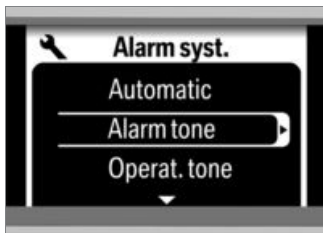

The following settings are available:

- **Automatic mode - On:** alarm system activated automatically after switching off the ignition.
- **Automatic mode - Off:** alarm system must be activated using the remote key after having switched off the ignition.
- **Alarm tone:** alarm tone type.
- **Key sound - On:** confirmation by the turn indicators and a sound after having switched the alarm system on/off.
- **Key sound - Off:** confirmation by the turn indicators only;

after having switched the alarm system on/off.

- Configure the desired settings using the Multi-Controller.

Heating

Operating the heated handlebar grips

- Start the engine.



NOTICE

The heating in the heated handlebar grips can be activated only when the engine is running. ◀

- Call up the `Handle heat.` menu.

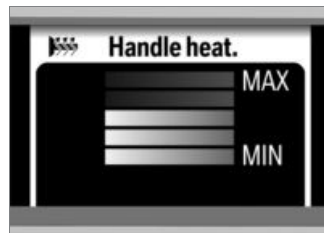

The grips can be heated in five levels. The fifth level is intended to quickly heat up the grips; you should then shift down to one of the lower levels.

- Select the heating stage you want.



The symbol **1** shows that the grip heating is switched on.

Front-seat heating

– with seat heating^{OE}

- Start the engine.

NOTICE

Seat heating can be activated only when the engine is running.◀

- Call up the *Seat heating* menu.

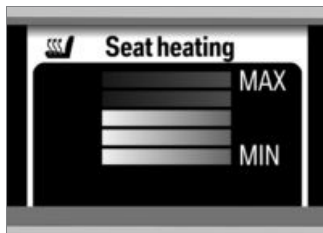

The rider's seat can be heated in five levels. The fifth level is intended to quickly heat up the seat; you should then shift down to one of the lower levels.

- Select the heating stage you want.



The symbol **1** shows that the rider's seat heating is switched on.

 If this warning symbol appears it tells you that the on-board system voltage is low. If applicable, the seat heating might have been temporarily switched off.

Front seat

Removing front seat

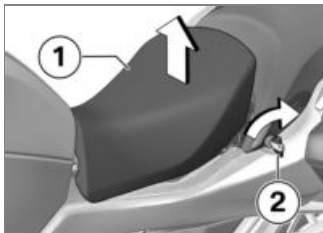

- Turn ignition key **2** clockwise.
- Slightly raise front seat **1** at the back.



- Work front seat **1** to the rear to disengage it from seat retainer bridge **3** and remove.

- with seat heating^{OE}
- Disconnect plug **2** for the seat heating.<
- Remove the front seat and place it, upholstered side down, on a clean, dry surface.

Installing front seat

– with seat heating^{OE}



- Connect plug **1** of the seat heating.<

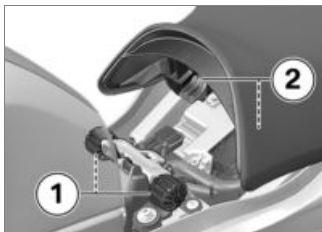

- Position the front seat with mounts **2** in rubber buffers **1** on left and right.
- Lower the rear of the front seat and engage the seat in the latching mechanism.

Adjusting front-seat height

- Removing front seat (➡ 100).



- Push latch **1** forward and remove adjusting plate **2**.

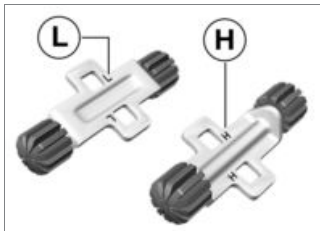

- Turn the adjusting plate to position **L** for the lower seat height.

- Turn the adjusting plate to position **H** for the higher seat height.

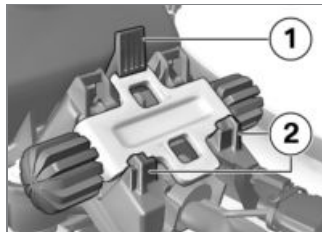

- Insert the adjusting plate in the desired position into mounts **2** and then push it into latch **1**.
- Installing front seat (➡ 100).

Rear seat

Removing rear seat

- Switch off the ignition.
- Removing front seat (➡ 100).

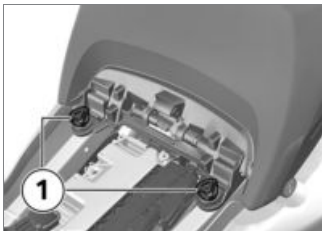

- Remove the screws **1**.
- Slightly pull the passenger seat towards the front and lift it.
- Place the seat, upholstered side down, on a clean surface.

Install the rear seat



- Place passenger seat on the mountings **1**.

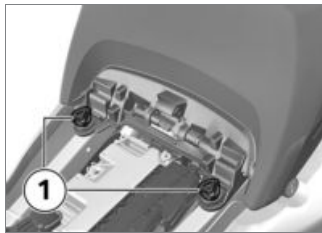

- Fit bolts **1**.

Adjusting spray guard

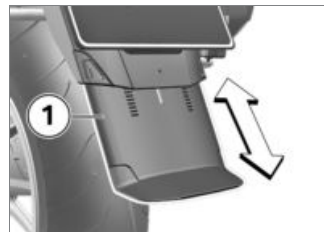

- Move spray guard **1** up or down.
- » Spray guard **1** engages at the selected position.

Stowage compartment Operating the left storage compartment



- Unlock and lock the lock **1** of the storage compartment using the ignition key.
- To open the lid, press the unlocked lock barrel down.

ATTENTION

High temperatures in the storage compartments, particularly in summer

Damage to objects stowed away, particularly electronic devices,

such as mobile phones and MP3 players

- Consult the operating instructions of your electronic device and check for possible usage restrictions.◀
- In summer, do not place heat-sensitive objects in the storage compartments.

Central locking system Lock

– with central locking system^{OE}



- Switch on the ignition and press button **3**.

- Alternatively: press button **1** on the remote control.
 - » The stowage compartment in the left side panel and the cases are locked.
 - with topcase^{OA}
 - » The topcase is locked.◀
 - » These locks cannot subsequently be unlocked manually.

 The locked symbol appears on the display.

- with anti-theft alarm (DWA)^{OE}
 - » The functions of the remote control for the anti-theft alarm are described in the corresponding section.◀

Unlocking

– with central locking system^{OE}



- Switch on the ignition and press button **3**.
- Alternatively: Press button **2** on the remote control.
 - » The stowage compartment in the left side panel and the cases are unlocked.
 - » The stowage compartment in the right side panel is unlocked.
- with topcase^{OA}
 - » The topcase is unlocked.<
 - » Once a lock has been locked manually it subsequently has to be unlocked manually as well.

- with anti-theft alarm (DWA)^{OE}
 - » The functions of the remote control for the anti-theft alarm are described in the corresponding section.<

Emergency unlocking

- with central locking system^{OE}

If the central locking system refuses to unlock, you can open the cases, topcase and stowage compartments manually. The procedure is as follows:

- Removing cases (➡ 192).
- Open cases (➡ 191).

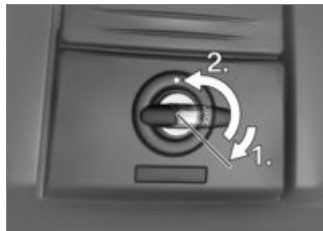

- First turn the key in the topcase lock 45° past the LOCK position, then turn it to the dot position and press in the lock barrel.
 - » The release lever pops open.

Logon of remote controls

- with central locking system^{OE}
- with anti-theft alarm (DWA)^{OE}
- without Keyless Ride^{OE}

If a remote control has been mislaid and a replacement acquired or if you are going to use an additional remote control, you must

invariably log on all the remote controls in the set.

- Enable logon of the remote controls as follows:
- Switch on the ignition.

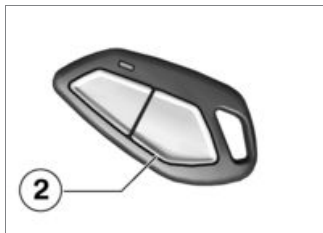

- Press button **2** on the remote control three times.
 - » One acoustic signal sounds.
- Within ten seconds, switch off the ignition.

You can now proceed to log on all the remote controls.

- Step through the following procedure with each remote control in turn:

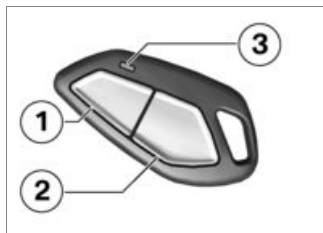

- Press and hold down buttons **1** and **2** until LED **3** stops flashing.
 - » LED **3** flashes for approx. 10 seconds.
- Release buttons **1** and **2**.
 - » LED **3** lights up.
- Press button **1** or button **2**.
 - » One acoustic signal sounds, LED **3** goes out.

To complete logon:

- Switch off the ignition.
 - » Three acoustic signals sound.
- » Logon is also ended in the following situations:

- 4 remote control units have been logged on.
- No button pressed within approximately 30 seconds of logon on the first remote control.

Synchronise the remote controls

- with central locking system^{OE}
- with anti-theft alarm (DWA)^{OE}
- without Keyless Ride^{OE}

If the central locking system stops responding to the signals from a remote control, the unit in question has to be synchronised. This can happen, for example, if the buttons on the remote control were pressed too frequently while the remote control was out of range of the anti-theft alarm.

- The procedure for synchronising the remote controls is as follows:

- Switch on the ignition.

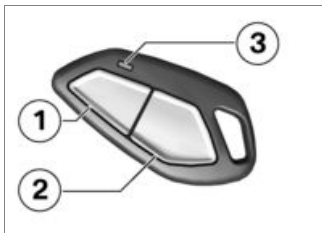

- Press and hold down buttons **1** and **2** until LED **3** stops flashing.
 - » LED **3** flashes for about ten seconds.
- Release buttons **1** and **2**.
 - » LED **3** lights up.
- Press button **1** or button **2**.
 - » LED **3** goes out.

Replacing battery of remote control

- with central locking system^{OE}
- with anti-theft alarm (DWA)^{OE}
- without Keyless Ride^{OE}

If you press a button on the remote control and the LED does not show or lights up only briefly:

- Replace the battery of remote control.

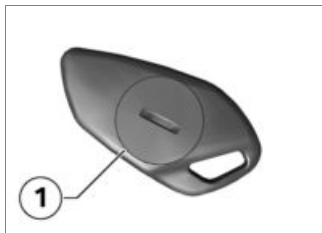

- Open battery-compartment cover **1**.
- Dispose of the old battery in accordance with all applicable laws and regulations; do not

attempt to dispose of batteries as domestic waste.



ATTENTION

Unsuitable or incorrectly inserted batteries

Component damage

- Use a battery compliant with the manufacturer's specifications.
- When inserting the battery, always make sure polarity is correct. ◀
- Insert the new battery with the positive terminal up.



Battery type

for remote control of central locking

CR 1632

- » The LED on the remote control lights up; the remote control has to be synchronised.

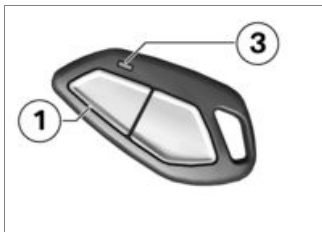

- Press button **1** twice.
 - » LED **3** flashes for a few seconds.
 - » The remote control is again ready for use.

Adjustment

Mirrors	110
Headlight	110
Windscreen	110
Instrument panel	111
Clutch	112
Brakes	112
Spring preload	113
Damping	114

Mirrors

Adjusting mirrors



- Pivot the mirror to the correct position by pressing gently at the edge of the glass.

Headlight

Headlight beam throw and spring setting

The headlight beam throw generally remains constant due to adjustment of the spring setting. Adjustment of the spring setting may only be inadequate if the load is very high. In this case, the

headlight beam throw must be adjusted to the weight.



NOTICE

If there are doubts about the correct headlight beam throw, have the setting checked by a specialist workshop, preferably an authorised BMW Motorrad dealer. ◀

Adjusting headlight beam throw

Requirement

If, with a high load, the adjustment of the spring setting is no longer sufficient not to dazzle oncoming traffic:

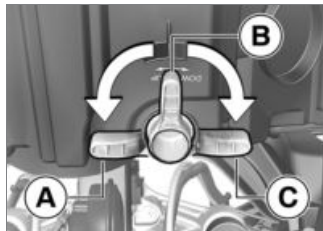

- The headlight beam-throw is adjusted via a bell crank.
 - **A** Position with a light load (only rider)
 - **B** Position with rider with load
 - **C** Position with high load (with two-up mode)

Windscreen

Adjusting windscreen

- Switch on the ignition.
 - » As you ride off, the windscreen automatically moves to its last position before the ignition was switched off.



Correct anti-trap mechanism functionality cannot be guaranteed if a windscreen has been installed that has not been approved by BMW Motorrad.

- In this case: Ensure the clearance of the windscreen prior to switching off the ignition.

Instrument panel Adjusting instrument panel

NOTICE

Do not attempt to adjust the position of the instrument panel unless the vehicle is at a standstill. ◀

- Press the upper section of button **1** to raise the windscreen.
- Press the lower section of button **1** to lower the windscreen.
- Switch off the ignition.
 - » The windscreen automatically moves to the bottom end position.
 - » The anti-trap mechanism activates if the windscreen encounters resistance prior to reaching the end position. The windscreen stops and the mechanism raises it slightly. After a few seconds the windscreen once again attempts to move to the bottom end position.

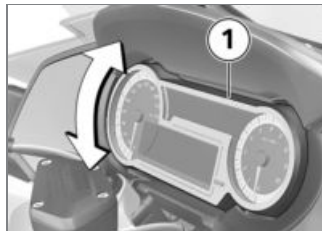

- Press instrument panel **1** firmly at top or bottom edge, as applicable, to move it to the desired position. Be sure to apply pressure midway along the edge in order to ensure that movement is the same at both sides.

Clutch

Adjust the clutch lever

WARNING

Adjusting the clutch lever while riding

Risk of accident

- Adjust the clutch lever only when the motorcycle is at a standstill. ◀

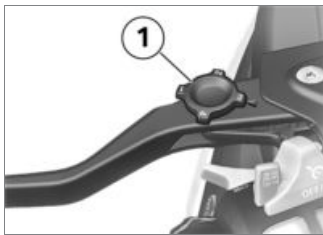

- Turn adjuster knob **1** to the desired position.



NOTICE

The adjuster is easier to turn if you push the clutch lever forward. ◀

- » Four settings are possible:
 - Position 1: smallest distance between handlebar grip and clutch lever
 - Position 4: largest distance between handlebar grip and clutch lever

Brakes

Adjust the handbrake lever



WARNING

Adjusting the brake lever while riding

Risk of accident

- Do not attempt to adjust the brake lever unless the motorcycle is at a standstill. ◀

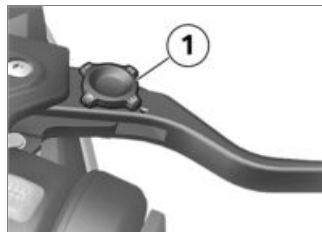

- Turn adjuster knob **1** to the desired position.



NOTICE

The adjuster is easier to turn if you push the brake lever forward. ◀

- » Four settings are possible:
 - Position 1: Smallest distance between handlebar grip and brake lever.
 - Position 4: Largest distance between handlebar grip and brake lever.

Spring preload

Adjustment

It is essential to set spring preload of the rear suspension to suit the load carried by the motorcycle. Increase spring preload when the vehicle is heavily loaded and reduce spring preload accordingly when the vehicle is lightly loaded.

Adjusting spring preload for rear wheel

WARNING

Adjusting spring preload while riding.

Risk of accident

- Do not attempt to adjust spring preload unless the motorcycle is at a standstill.◀
- Make sure the ground is level and firm and place the motorcycle on its stand.

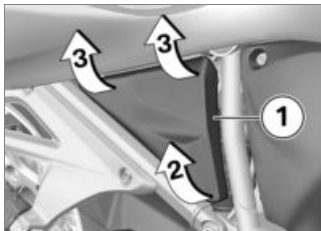

- Ease out bottom of cover **1** at position **2**.
- In order not to damage the cover or the mounts, disengage the cover at positions **3**.

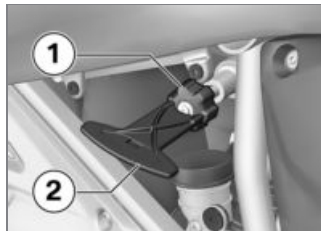

WARNING

Spring preload setting and spring-strut damping setting not matched.

Impaired handling.

- Adjust spring-strut damping to suit spring preload.◀
- If you want to increase spring preload, use tool **2** (on-board toolkit) to turn knob **1** clockwise.
- If you want to reduce spring preload, use tool **2** to turn knob **1** counter-clockwise.



Basic setting of spring preload, rear

– without Dynamic ESA^{OE}

Turn the adjuster knob as far as it will go counter-clockwise. (One-up without luggage)

Turn the adjuster knob as far as it will go counter-clockwise, then back it off 10 turns in the clockwise direction. (One-up with luggage)

Turn the adjuster knob as far as it will go clockwise. (Two-up with luggage)



- Seat the cover in mount **2** and press it into mounts **1**.

Damping Adjustment

Damping must be adapted to suit the surface on which the motorcycle is ridden and to suit spring preload.

- An uneven surface requires softer damping than a smooth surface.
- An increase in spring preload requires firmer damping, a reduction in spring preload requires softer damping.

Adjusting the damping characteristic for rear wheel

- Place the motorcycle on its stand on firm, even ground.
- Set the damping from the left-hand vehicle side.



- Turn the adjusting screw **1** clockwise to harden the damping action.
- Turn the adjusting screw **1** anticlockwise to soften the damping action.



NOTICE

BMW Motorrad recommends selecting one-up operation with luggage for special vehicles. ◀



Basic setting of rear-suspension damping characteristic

– without Dynamic ESA^{OE}

Turn the adjuster knob as far as it will go in the clockwise direction, then back it off 6 clicks in the counter-clockwise direction. (One-up without luggage)

Turn the adjuster knob as far as it will go in the clockwise direction, then back it off 4 clicks in the counter-clockwise direction. (One-up with luggage)



Basic setting of rear-suspension damping characteristic

Turn the adjuster knob as far as it will go in the clockwise direction, then back it off 2 clicks in the counter-clockwise direction. (Two-up with luggage) ◀

Riding

Safety information	118
Comply with checklist.....	120
Always before riding off	120
Every 3rd refuelling stop	120
Starting	121
Running in	124
Shifting gear	125
Brakes	126
Parking your motorcycle	128
Refuelling	129
Securing motorcycle for transportation	133

Safety information

Rider's equipment

Do not ride without the correct clothing! Always wear:

- Helmet
- Suit
- Gloves
- Boots

This applies even to short journeys, and to every season of the year. Your authorised BMW Motorrad dealer will be glad to advise you on the correct clothing for every purpose.



ATTENTION

Use of non-colour-fast materials (e.g. blue jeans) on the seat

Discolouration on the seat

- Avoid contact with non-colour-fast materials.◀

Loading



WARNING

Handling adversely affected by overloading and imbalanced loads

Risk of falling

- Do not exceed the permissible gross weight and be sure to comply with the instructions on loading.◀
- Adapt spring setting and damping adjustment to the total weight.
- Ensure that the case volumes on the left and right are equal.
- Make sure that the weight is uniformly distributed between right and left.
- Pack heavy items at the bottom and toward the inboard side.
- Note the maximum permissible payload and maximum speed for riding with cases fitted, as

stated on the label inside the case (see also the chapter "Accessories").

- Note the maximum permissible payload and maximum speed for riding with topcase fitted, as stated on the label inside the topcase (see also the chapter "Accessories").
- with tank bag^{OA}
- Observe maximum load capacity of the tank bag.



Payload of tank rucksack

max 5 kg◀

Speed

If you ride at high speed, always bear in mind that various boundary conditions can adversely affect the handling of your motorcycle:

- Settings of the spring-strut and shock-absorber system
- Imbalanced load
- Loose clothing
- Insufficient tyre pressure
- Poor tyre tread
- Etc.

Maximum permissible speed with winter tyres

DANGER

Maximum speed of the motorcycle is higher than the permissible maximum rated speed of the tyres

Risk of accident due to tyre damage at high speed

- Comply with the tyre-specific speed restrictions.◀

Always bear the maximum permissible speed of the tyres in mind when riding a motorcycle fitted with winter tyres.

Affix a label stating the maximum permissible speed to the instrument panel in the rider's field of vision.

Risk of poisoning

Exhaust fumes contain carbon monoxide, which is colourless and odourless but highly toxic.

WARNING

Exhaust gases adversely affecting health

Risk of asphyxiation

- Do not inhale exhaust fumes.
- Do not run the engine in an enclosed space.◀

Risk of burn injury

CAUTION

Engine and exhaust system become very hot when the vehicle is in use

Risk of burn injury

- When you park the vehicle make sure that no-one and no objects can come into contact with the hot engine and exhaust system.◀

Catalytic converter

If misfiring causes unburned fuel to enter the catalytic converter, there is a danger of overheating and damage.

The following guidelines must be observed:

- Do not run the fuel tank dry.
- Do not attempt to start or run the engine with a spark-plug cap disconnected.
- Stop the engine immediately if it misfires.
- Use only unleaded fuel.
- Comply with all specified maintenance intervals.

**ATTENTION****Unburned fuel in catalytic converter**

Damage to catalytic converter

- Note the points listed for protection of the catalytic converter.◀

Risk of overheating**ATTENTION****Engine running for prolonged period with vehicle at standstill**

Overheating due to insufficient cooling; in extreme cases vehicle fire

- Do not allow the engine to idle unnecessarily.
- Ride away immediately after starting the engine.◀

Tampering**ATTENTION****Tampering with the motorcycle (e.g. engine management ECU, throttle valves, clutch)**

Damage to the affected parts, failure of safety-relevant functions, voiding of warranty

- Do not tamper with the vehicle in any way that could result in tuned performance.◀

Comply with checklist

- At regular intervals, use the checklist below to check your motorcycle.

Always before riding off

- Check operation of the brake system.
- Check operation of the lights and signalling equipment.

- Checking clutch function (▣▣▣ 160).
- Checking tyre tread depth (▣▣▣ 163).
- Checking tyre pressure (▣▣▣ 162).
- Check that cases and luggage are securely held in place.
 - without Dynamic ESA^{OE}
- Adjusting spring preload for rear wheel (▣▣▣ 113).
- Adjusting the damping characteristic for rear wheel (▣▣▣ 114).◀

Every 3rd refuelling stop

- Checking engine oil level (▣▣▣ 154).
- Checking front brake pad thickness (▣▣▣ 156).
- Checking rear brake pad thickness (▣▣▣ 157).

- Checking brake-fluid level, front brakes (➡ 158).
- Checking the brake-fluid level, rear brakes (➡ 159).
- Check coolant level (➡ 160).

Starting

Start engine

- Switch on the ignition.
 - » Pre-Ride-Check is performed. (➡ 121)
 - » ABS self-diagnosis is in progress. (➡ 122)
 - » ASC self-diagnosis is performed. (➡ 123)
- Select neutral or, if a gear is engaged, pull the clutch lever.

NOTICE

You cannot start the motorcycle with the side stand extended and a gear engaged. The engine will switch itself off if you start it with the gearbox in neutral and then

engage a gear before retracting the side stand.◀

- When starting a cold engine at low ambient temperatures: disengage the clutch and turn the twistgrip slightly to open the throttle.



- Press starter button **1**.

NOTICE

The start attempt is automatically interrupted if battery voltage is too low. Recharge the battery before you start the engine, or

use jump leads and a donor battery to start.

See the subsection on jump starting in "Maintenance" for more details.◀

- » The engine starts.
- » If the engine refuses to start, consult the troubleshooting chart in the section entitled "Technical data". (➡ 212)

Pre-Ride-Check

The instrument cluster runs a test of the general warning light with the Pre-Ride-Check when the ignition is switched on.

Phase 1

 lights up yellow.

- » Needles of the instruments move from the start to the end point once.

Phase 2

lights up red.

Phase 3

- » General warning light goes out and display changes to operating information.
- » The malfunction indicator lamp only goes out after 15 seconds.

If the general warning light is not shown:

**WARNING****Faulty "General" warning light.**

No indication of malfunctions.

- Check that the 'General' warning light comes on, and that it shows red and yellow.◀
- Have the fault rectified as quickly as possible by a specialist workshop, preferably

an authorised BMW Motorrad Retailer.

ABS self-diagnosis

BMW Motorrad Integral ABS performs self-diagnosis to ensure its operability. Self-diagnosis starts automatically when you switch on the ignition.

Phase 1

- » Test of the diagnosis-compatible system components with the vehicle at a standstill.



flashes.

Phase 2

- » Test of the wheel-speed sensors as the vehicle pulls away from rest.



flashes.

ABS self-diagnosis completed

- » The ABS indicator and warning light goes out.



ABS self-diagnosis not completed

The ABS function is not available, because self-diagnosis did not complete. (The motorcycle has to reach a defined minimum speed for the wheel speed sensors to be checked: 5 km/h)

If an indicator showing an ABS fault appears when ABS self-diagnosis completes:

- You can continue to ride. Bear in mind that neither the ABS function nor the integral braking function is available.
- Have the fault rectified as quickly as possible by a specialist workshop, preferably

an authorised BMW Motorrad dealer.

ASC self-diagnosis

BMW Motorrad ASC performs self-diagnosis to ensure its operability. Self-diagnosis is performed automatically when you switch on the ignition.

Phase 1

» Test of the diagnosable system components with the vehicle at a standstill.



slow-flashes.

Phase 2

» Test of the diagnosis-compatible system components while the motorcycle is on the move.



slow-flashes.

ASC self-diagnosis completed

» The ASC indicator and warning light goes out.

- Check all the indicator and warning lights.



ASC self-diagnosis not completed

The ASC function is not available, because self-diagnosis did not complete. (The motorcycle has to reach a defined minimum speed for the wheel sensors to be checked: min 5 km/h)

If an indicator showing an ASC fault appears when ASC self-diagnosis completes:

- You can continue to ride. Bear in mind that the ASC function is not available.
- Have the fault rectified as quickly as possible by a specialist workshop, preferably

an authorised BMW Motorrad dealer.

DTC self-diagnosis

– with riding modes Pro^{OE}

BMW Motorrad DTC performs self-diagnosis to ensure its operability. Self-diagnosis is performed automatically when you switch on the ignition.

Phase 1

» Test of the diagnosable system components with the vehicle at a standstill.



slow-flashes.

Phase 2

» Test of the diagnosis-compatible system components while the motorcycle is on the move.



slow-flashes.

DTC self-diagnosis completed

- » The DTC indicator and warning light goes out.
- Check all the indicator and warning lights.

 DTC self-diagnosis not completed

The DTC function is not available, because self-diagnosis did not complete. (The motorcycle has to reach a defined minimum speed with the engine running for the wheel-speed sensors to be checked: min 5 km/h)

If an indicator showing an DTC fault appears when DTC self-diagnosis completes:

- You can continue to ride. Bear in mind that the DTC function is not available or the functionality might be subject to certain restrictions.

- Have the fault rectified as quickly as possible by a specialist workshop, preferably an authorised BMW Motorrad dealer.

Running in Engine

- Until the first running-in check, vary the throttle opening and engine-speed range frequently; avoid riding at constant engine rpm for prolonged periods.
- Try to do most of your riding during this initial period on twisting, fairly hilly roads, avoiding high-speed main roads and highways if possible.
- Comply with the rpm limits for running in.

 Running-in speeds

<5000 min⁻¹ (Odometer reading 0...1000 km)



Running-in speeds

No full load (Odometer reading 0...1000 km)



Running-in check

500...1200 km

Brake pads

New brake pads have to bed down before they can achieve their optimum friction levels. You can compensate for this initial reduction in braking efficiency by exerting greater pressure on the levers.



WARNING

New brake pads

Longer stopping distance, risk of accident

- Apply the brakes in good time. ◀

Tyres

New tyres have a smooth surface. This must be roughened by riding in a restrained manner at various heel angles until the tyres are run in. This running in procedure is essential if the tyres are to achieve maximum grip.

WARNING

New tyres losing grip on wet roads and at extreme bank angles

Risk of accident

- Ride carefully and avoid extremely sharp inclines. ◀

Shifting gear

– with shift assistant Pro^{OE}

Shift assistant Pro Requirement

The shift assistant assists upshifts and downshifts without the rider having to pull the clutch or

close the throttle. This is not an automatic-shift system. The rider is the most important part of the system and decides when to shift gears.

NOTICE

See the section entitled "Engineering details" for more information on the Pro shift assistant. ◀

NOTICE

Whenever the Pro shift assistant shifts down, cruise control is automatically disengaged for safety reasons. ◀

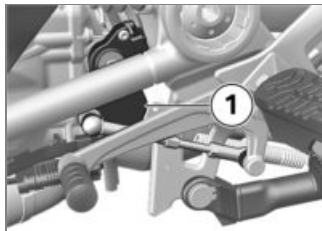

- You select the gear in the usual way by means of the foot-operated shift lever.
- » The sensor **1** on the gearshift shaft registers the gearshift request and triggers shift assistance.
- » When riding at a steady speed in a low gear at high engine rpm, an attempt to shift gear without pulling the clutch can cause a severe load-change reaction. BMW Motorrad recommends disengaging the clutch for shifts in these circumstances. It is advisable to avoid using the shift assistant

at engine speeds close to the limits at which the governor cuts in to limit engine rpm.

- » Shift assistance is not available in the following situations:
 - With clutch lever pulled.
 - Gearshift lever not in its initial position.
 - Upshifts with the throttle valve closed (coasting overrun) and when decelerating.
 - When shifting down with the throttle valve open or when accelerating.
- After a gearshift, the shift lever has to be fully released before another gearshift with the shift assistant can take place.

Brakes

How can stopping distance be minimised?

Each time the brakes are applied, a load distribution shift takes place with the load shifting forward from the rear to the front wheel. The sharper the motorcycle decelerates, the more load is shifted to the front wheel. The higher the wheel load, the more braking force can be transmitted without the wheel locking.

To optimise stopping distance, apply the front brakes rapidly and keep on increasing the force you apply to the brake lever. This makes the best possible use of the dynamic increase in load at the front wheel. Remember to pull the clutch at the same time. In the extreme braking situations that are trained so frequently, braking force is applied as rapidly as possible and with the

rider's full force applied to the brake levers; under these circumstances, the dynamic shift in load distribution cannot keep pace with the increase in deceleration and the tyres cannot transmit the full braking force to the surface of the road.

BMW Motorrad Integral ABS prevents the front wheel from locking up.

Hazard braking

If you brake sharply from a speed in excess of 50 km/h, the brake light flashes rapidly as an additional warning for road users behind you.

The hazard warning lights system switches on if you brake to below 15 km/h in this process. The hazard warning lights system automatically switches off from a speed of 20 km/h.

Descending mountain passes

WARNING

Braking only with the rear brake on mountain descents

Brake fade, destruction of the brakes due to overheating

- Use both front and rear brakes, and make use of the engine's braking effect as well. ◀

Wet and dirty brakes

Wetness and dirt on the brake discs and the brake pads diminish braking efficiency.

Delayed braking action or poor braking efficiency must be reckoned with in the following situations:

- Riding in the rain or through puddles of water.
- After the vehicle has been washed.

- Riding on salted or gritted roads.
- After work has been carried on the brakes, due to traces of oil or grease.
- Riding on dirt-covered surfaces or off-road.

WARNING

Wetness and dirt result in diminished braking efficiency

Risk of accident

- Apply the brakes lightly while riding to remove wetness and dirt, or dismount and clean the brakes.
- Think ahead and brake in good time until full braking efficiency is restored. ◀

ABS Pro

Physical limits applicable to motorcycling

WARNING

Braking when cornering

Risk of crash despite ABS Pro

- Invariably, it remains the rider's responsibility to adapt riding style to riding conditions.
- Do not take risks that would negate the additional safety offered by this system. ◀

ABS Pro is available in all riding modes.

- with riding modes Pro^{OE}
The Dynamic Brake Control supporting function is also available.

Possibility of a fall not precluded

Although ABS Pro provides the rider with valuable assistance and constitutes a huge advance in

safety for braking with the motorcycle banked for cornering, it cannot under any circumstances be considered as redefining the physical limits that apply to motorcycling. It is still possible for these limits to be overshoot due to misjudgement or rider error. In extreme cases this can result in a crash.

Use on public roads

ABS Pro helps make the motorcycle even safer for riding on public roads. When the brakes are applied because of an unforeseen hazard when the motorcycle is banked for cornering, within the physical limits that apply to motorcycling the system prevents the wheels from locking and skidding away.

NOTICE

ABS Pro was not developed to enhance individual braking per-

formance with the motorcycle banked into corners.◀

– with riding modes Pro^{OE}
During emergency braking, Dynamic Brake Control increases the braking effect and intervenes if the throttle grip is accidentally actuated during the braking process.

Parking your motorcycle

Side stand

- Switch off the engine.

ATTENTION

Poor ground underneath the stand

Risk of damage to parts if vehicle topples

- Always check that the ground under the stand is level and firm.◀

ATTENTION

Additional weight placing strain on the side stand

Risk of damage to parts if vehicle topples

- Do not sit or lean on the vehicle while it is propped on the side stand.◀
- Extend the side stand and prop the motorcycle on the stand.
- Turn the handlebars all the way to left.
- On a gradient, the motorcycle should always face uphill; select 1st gear.

Centre stand

- Switch off the engine.

ATTENTION

Poor ground underneath the stand

Risk of damage to parts if vehicle topples

- Always check that the ground under the stand is level and firm. ◀

ATTENTION

Centre stand folds in due to sharp movements

Risk of damage to parts if vehicle topples

- Do not lean or sit on the vehicle with the centre stand extended. ◀
- Extend the centre stand and lift the motorcycle onto the stand.
- On a gradient, the motorcycle should always face uphill; select 1st gear.

Refuelling

Fuel grade Requirement

To ensure optimal fuel consumption, fuel should be sulphur-free or as low-sulphur as possible.



ATTENTION

Engine operation with leaded fuel

Damage to catalytic converter

- Do not attempt to run the vehicle on leaded fuel or fuel with metallic additives (e.g. manganese or iron). ◀
- Observe the maximum ethanol content of the fuel.

 Recommended fuel grade

-  Super unleaded (maximum 15 % ethanol, E15)
-  95 ROZ/RON
90 AKI



Alternative fuel grade



Normal unleaded (power- and consumption-related restrictions.) (max 15 % ethanol, E10/E15)
91 ROZ/RON
87 AKI

» Pay attention to the following symbols in the fuel filler cap and on the fuel pump:



» After refuelling with fuels of poor-quality, sporadic knocking noises may be perceptible.

Refuelling

WARNING

Fuel is highly flammable

Risk of fire and explosion

- Do not smoke. Never bring a naked flame near the fuel tank. ◀

WARNING

Escape of fuel due to heat-induced expansion if fuel tank is overfilled

Risk of falling

- Do not overfill the fuel tank. ◀

ATTENTION

Wetting of plastic surfaces by fuel

Damage to the surfaces (surfaces become unsightly or dull)

- Clean plastic surfaces immediately after contact with fuel. ◀

- Make sure the ground is level and firm and place the motorcycle on its centre stand.

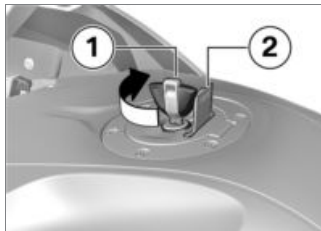

- Open the protective cap **2**.
- Unlock the fuel tank cap by turning the ignition key **1** clockwise and open up.



- Refuel with fuel up to the lower edge of the filler neck.

NOTICE

When refuelling after running on reserve, make sure that you top up the tank to a level above reserve, so that the new level is detected and the fuel reserve indicator light is switched off. ◀

NOTICE

The "usable fuel capacity" specified in the technical data is the quantity that the fuel tank could hold if refilled after it had been

run dry and the engine had cut out due to a lack of fuel.◀

 Usable fuel capacity
approx. 25 l

 Reserve fuel
approx. 4 l

- Press the fuel tank cap down firmly to close.
- Remove the ignition key and close the protective cap.

Refuelling

– with Keyless Ride^{OE}

Requirement

The steering lock is disengaged.

WARNING

Fuel is highly flammable

Risk of fire and explosion

- Do not smoke. Never bring a naked flame near the fuel tank.◀

WARNING

Escape of fuel due to heat-induced expansion if fuel tank is overfilled

Risk of falling

- Do not overfill the fuel tank.◀

ATTENTION

Wetting of plastic surfaces by fuel

Damage to the surfaces (surfaces become unsightly or dull)

- Clean plastic surfaces immediately after contact with fuel.◀
- Make sure the ground is level and firm and place the motorcycle on its centre stand.
- with Keyless Ride^{OE}
- Switching off ignition (▣ 58).

NOTICE

The fuel filler cap can be opened within the defined waiting time after the ignition has been switched off, without the radio-operated key being within range.◀

 Waiting time for opening fuel filler cap

2 min

- » There are **two variant ways** of opening the fuel filler cap:
- Within the after-running period.
 - After the after-running period has expired.

Version 1

– with Keyless Ride^{OE}

Requirement

Within the waiting time

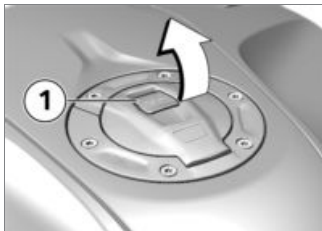

- Slowly pull tab **1** on the fuel filler cap up.
- » Fuel filler cap unlocks.
- Fully open the fuel filler cap.

Version 2

– with Keyless Ride^{OE}

Requirement

After the waiting time has expired

- Bring the radio-operated key into range.
- Slowly pull tab **1** up.
- » The telltale light for the radio-operated key flashes while the

search for the radio-operated key is in progress.

- Again slowly pull up tab **1** of the fuel filler cap.
- » Fuel filler cap unlocks.
- Fully open the fuel filler cap.



- Refuel with fuel of the grade stated above; do not fill the tank past the bottom edge of the filler neck.



NOTICE

When refuelling after running on reserve, make sure that you top up the tank to a level above reserve, so that the new level is

detected and the fuel reserve indicator light is switched off. ◀



NOTICE

The "usable fuel capacity" specified in the technical data is the quantity that the fuel tank could hold if refilled after it had been run dry and the engine had cut out due to a lack of fuel. ◀



Usable fuel capacity

approx. 25 l



Reserve fuel

approx. 4 l

- Press down firmly on the filler cap of the fuel tank.
- » The fuel filler cap engages with an audible click.

- » The fuel filler cap locks automatically when the waiting time expires.
- » The engaged fuel filler cap locks immediately when you secure the steering lock or switch on the ignition.

Securing motorcycle for transportation

- Make sure that all components that might come into contact with straps used to secure the motorcycle are adequately protected against scratching. Use adhesive tape or soft cloths, for example, for this purpose.



ATTENTION

Vehicle topples to side when being lifted on to stand

- Risk of damage to parts if vehicle topples
- Secure the vehicle to prevent it toppling, preferably with the assistance of a second person.◀
 - Push the motorcycle onto the transportation flat and hold it in position: do not place it on the side stand or centre stand.



ATTENTION

Trapping of components

Component damage

- Do not trap components such as brake lines or cable legs.◀
- Guide left and right tensioning straps through the fork bridge and tension at the bottom.

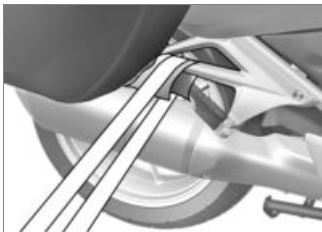

- Secure the tensioning straps behind on both sides on the bracket for the rear footrest and tighten.
- Tension all tensioning straps evenly so that the motorcycle is securely fastened.

Engineering details

General instructions.....	136
Antilock Brake System (ABS)	136
Automatic Stability Control (ASC)	139
Dynamic Traction Control (DTC)	141
Electronic Suspension Adjustment (D-ESA).....	142
Riding mode	143
Dynamic Brake Control	145
Tyre pressure control (RDC)	146
Shift assistant.....	147
Hill Start Control	149
Engine run-on circuit.....	150

General instructions

To find out more about engineering go to:

bmw-motorrad.com/technology

Antilock Brake System (ABS)

Partially integral brakes

Your motorcycle is equipped with partially integral brakes. Both front and rear brakes are applied when you pull the handbrake lever. The footbrake lever acts only on the rear brake.

When actively intervening in the braking process, BMW Motorrad Integral ABS adapts braking-force distribution between front and rear brakes to suit the load on the motorcycle ABS.



ATTENTION

Attempted burn-out despite Integral braking function

Damage to rear brake and clutch

- Do not burn out tyres.◀

How does Integral ABS work?

The amount of braking force that can be transferred to the road depends on factors that include the coefficient of friction of the road surface. Loose stones, ice and snow or a wet road all have much lower coefficients of friction than a clean and dry asphalt surface. The lower the coefficient of friction, the longer the braking distance.

If the rider increases braking pressure to the extent that braking force exceeds the maximum transferable limit, the wheels start to lock and the vehicle loses its directional stability; a fall is im-

minent. Before this situation can occur, ABS intervenes and adapts braking pressure to the maximum transferable braking force. The wheels continue to turn and the driving stability is retained irrespective of the road condition.

What are the effects of surface irregularities?

Humps and surface irregularities can cause the wheels to lose contact temporarily with the road surface; if this happens the braking force that can be transmitted to the road can drop to zero. If the brakes are applied under these circumstances the ABS has to reduce braking force to ensure that directional stability is maintained when the wheels regain contact with the road surface. At this instant the BMW Motorrad Integral ABS must assume an extremely low

coefficient of friction, so that the wheels will continue to rotate under all imaginable circumstances, because this is the precondition for ensuring directional stability. As soon as it registers the actual circumstances, the system reacts instantly and adjusts braking force accordingly to achieve optimum braking.

What feedback does the rider receive from the Integral ABS?

If the ABS has to reduce braking force on account of the circumstances described above, vibration is perceptible through the handbrake lever.

When the handbrake lever is pulled, brake pressure is also built up at the rear wheel by the integral function. If the brake pedal is depressed after the handbrake lever is pulled, the brake pressure built up

beforehand is perceptible as counter-pressure sooner than is the case when the brake pedal is depressed either before or at the same time as the brake lever is pulled.

Rear wheel lift

Under very severe and sudden deceleration, however, under certain circumstances it is possible that the BMW Motorrad Integral ABS will be unable to prevent the rear wheel from lifting clear of the ground. If this happens the outcome can be a highsiding situation in which the motorcycle can flip over.



WARNING

Rear wheel lift due to severe braking

Risk of falling

- When you brake sharply, bear in mind that ABS control cannot always be relied on to pre-

vent the rear wheel from lifting clear of the ground.◀

What is the design baseline for Integral ABS?

Within the limits imposed by physics, the BMW Motorrad Integral ABS ensures directional stability on any surface. The system is not optimised for special requirements that apply under extreme competitive situations off-road or on the track. The driving behaviour should be adapted to actual driving skills and the road conditions.

Special situations

The speeds of the front and rear wheels are compared as one means of detecting a wheel's incipient tendency to lock. If the system registers implausible values for a lengthy period the ABS function is deactivated for safety reasons and an ABS

fault message is issued. Self-diagnosis has to complete before fault messages can be issued.

In addition to problems with the BMW Motorrad ABS, exceptional riding conditions can also cause a fault message to be issued:

- Heating up with the motorcycle on the centre stand or an auxiliary stand, engine idling or with a gear engaged.
- Rear wheel locked by the engine brake for a lengthy period, for example while descending on a loose or slippery surface.

If a fault message is issued on account of exceptional riding conditions, you can reactivate the ABS function by switching the ignition off and on again.

What significance devolves on regular maintenance?

WARNING

Brake system not regularly serviced.

Risk of accident

- In order to ensure that the ABS is always maintained in optimum condition, it is essential for you to comply strictly with the specified inspection intervals. ◀

Reserves for safety

The potentially shorter braking distances which BMW Motorrad Integral ABS permits must not be used as an excuse for careless riding. ABS is primarily a means of ensuring a safety margin in genuine emergencies.

WARNING

Braking when cornering

Risk of accident despite ABS

- Invariably, the rider bears responsibility for assessing road and traffic conditions and adopting his or her style of riding accordingly.
- Do not take risks that would negate the additional margin of safety offered by this system. ◀

Evolution of ABS to ABS Pro

Until now, the BMW Motorrad ABS helped ensure a very high degree of safety for braking with the motorcycle upright and travelling in a straight line. Now ABS Pro offers enhanced safety for braking in corners as well. ABS Pro prevents the wheels from locking even under sharp braking. ABS Pro reduces abrupt changes in steering

force, particularly in panic-braking situations, counteracting the vehicle's otherwise natural but undesirable tendency to straighten up.

ABS intervention

Technically speaking, depending on the riding situation ABS Pro adapts ABS intervention to the motorcycle's bank angle. Signals for rate of roll and rate of yaw and lateral acceleration are used to calculate bank angle. As the motorcycle is heeled over more and more as it banks into a corner, an increasingly strict limit is imposed on the brake-pressure gradient for the start of brake application. This slows the build-up of brake pressure to a corresponding degree. Additionally, pressure modulation is more uniform across the range of ABS intervention.

Advantages for the rider

The advantages of ABS Pro for the rider are sensitive response and high braking and directional stability combined with best-case deceleration of the motorcycle, even when cornering.

Automatic Stability Control (ASC)

How does ASC work?

The BMW Motorrad ASC system compares the speed of rotation of the front wheel and the rear wheel. The differential is used to compute slip as a measure of the reserves of stability available at the rear wheel. If slip exceeds a certain limit, the engine control intervenes and adapts the engine torque accordingly.

What is the design baseline for ASC?

BMW Motorrad ASC has been designed as an assistance system for riders to use on public roads. The extent to which the rider affects ASC control can be considerable (weight shifts when cornering, items of luggage loose on the motorcycle), especially when the style of riding takes rider and machine close to the limits imposed by physics. The system is not optimised for special requirements that apply under extreme competitive situations off-road or on the track. The BMW Motorrad ASC can be deactivated in these cases.

WARNING

Risky riding

Risk of accident despite ASC

- Invariably, the rider bears responsibility for assessing road and traffic conditions and adopting his or her style of riding accordingly.
- Do not take risks that would negate the additional safety offered by this system. ◀

Special situations

In accordance with the laws of physics, the ability to accelerate is restricted more and more as the angle of heel increases. Consequently, there can be a perceptible lag in acceleration out of very tight bends.

The speeds of the front and rear wheels are compared as one means of detecting the rear wheel's incipient tendency to

spin or slip sideways. If the system registers implausible values for a lengthy period the ASC function is deactivated for safety reasons and an ASC fault message is issued. Self-diagnosis has to complete before fault messages can be issued.

The following exceptional riding conditions can lead to an automatic shutdown of the BMW Motorrad ASC:

- Riding for a lengthy period with the front wheel lifted off the ground (Wheelie) with ASC deactivated.
- Rear wheel rotating with the vehicle held stationary by applying the front brake (Burn Out).
- Heating up with the motorcycle on the centre stand or an auxiliary stand, engine idling or with a gear engaged.

Accelerating the motorcycle to a defined minimum speed after switching the ignition off and then on again reactivates the ASC.



Minimum speed for activation of ASC

min 5 km/h

If the front wheel lifts clear of the ground under severe acceleration, the ASC reduces engine torque until the front wheel regains contact with the ground. Under these circumstances, BMW Motorrad recommends rolling the throttle slightly closed so as to restore stability with the least possible delay.

When riding on a slippery surface, never snap the throttle twistgrip fully closed without pulling the clutch at the same time. Engine braking torque can

cause the rear wheel to lock, with a corresponding loss of stability. The BMW Motorrad ASC is unable to control a situation of this nature.

Dynamic Traction Control (DTC)

– with riding modes Pro^{OE}

How does the DTC work?

The DTC compares the speeds of the front and rear wheels. The differential is used to compute slip as a measure of the reserves of stability available at the rear wheel. If slip exceeds a certain limit, the engine control intervenes and adapts the engine torque accordingly.

The DTC has an incline sensor and is therefore able to adjust the wheel slip with greater sensitivity when cornering. This enables more dynamic driving whilst providing the same level of sta-

bility. In DYNAMIC mode, slight wheelies are possible with the aid of the DTC.

What is the design baseline for the DTC?

DTC is designed as an assistance system for the rider and for use on public roads. The extent to which the rider affects DTC control can be considerable (weight shifts when cornering, items of luggage loose on the motorcycle), especially when style of riding takes rider and machine close to the limits imposed by physics.

The system is not optimised for special requirements that apply under extreme competitive situations on the track. You have the option of deactivating the DTC for these circumstances.



Risky riding

Risk of accident despite DTC

- Invariably, the rider bears responsibility for assessing road and traffic conditions and adopting his or her style of riding accordingly.
- Do not take risks that would negate the additional safety offered by this system. ◀

Special situations

In accordance with the laws of physics, the ability to accelerate is restricted more and more as the angle of heel increases. Consequently, there can be a perceptible reduction in acceleration out of very tight bends.

The speeds of the front and rear wheels are compared and the angle of heel taken into account as one means of detecting the rear wheel's incipient tendency to spin or slip sideways. If the electronic processor receives values

that it considers implausible over a lengthy period, a dummy value is used for the angle of heel or the DTC function is switched off. Under these circumstances the indicator for a DTC fault shows. Self-diagnosis has to complete before fault messages can be issued.

A fault message from the DTC may occur in any of the following exceptional riding conditions.

Exceptional riding conditions:

- Riding for a lengthy period with the front wheel lifted off the ground (wheelie).
- Rear wheel rotating with the vehicle held stationary by applying the front brake (burn-out).
- Heating up with the motorcycle on an auxiliary stand, in neutral or with a gear engaged.

The DTC is reactivated by switching the ignition off and on again and then riding at a minimum speed.



Minimum speed for activation of DTC

min 5 km/h

If the front wheel is lifted in the RAIN and ROAD riding modes, the DTC reduces the engine torque and quickly places the front wheel on the ground again. However, slight wheelies which are supported by the DTC are permitted in DYNAMIC mode. Under these circumstances, BMW Motorrad recommends rolling the throttle slightly closed so as to restore stability with the least possible delay.

When riding on a slippery surface, never snap the throttle grip fully closed without pulling the clutch at the same time. Engine braking torque can cause the rear wheel to skid, with a corresponding loss of stability. The DTC is unable to control a situation of this nature.

Electronic Suspension Adjustment (D-ESA)

– with Dynamic ESA^{OE}

Riding position equaliser

The electronic chassis and suspension setting Dynamic ESA is able to adjust your motorcycle automatically to the load. If the spring setting is set to AUTO, the rider does not have to change the load setting.

When driving off and when riding, the system monitors the suspension at the rear wheel and corrects the spring setting

in order to set the correct riding position. The damping is also adjusted automatically to the load.

Via ride height sensors, Dynamic ESA detects the movements in the chassis and suspension and responds by adjusting the EDC valves. The chassis and suspension will thus be adapted to the characteristics of the terrain.

Dynamic ESA calibrates itself at regular intervals to ensure the system functions correctly.

Possible settings

Damping modes

- ROAD: Damping for comfortable on-road mode
- DYNA: Damping for dynamic on-road mode

Load settings

- AUTO: Active riding position equaliser with automatic adjust-

ment of the spring setting and damping

- MIN: Minimum spring setting
- MAX: Maximum spring setting
- The rider can select the MIN and MAX spring settings, but cannot change them. The riding position equaliser is inactive when set to MIN and MAX.

Riding mode

Riding mode

Riding mode selection

In order to adapt the motorcycle to weather conditions, road conditions and the rider's riding style, there is a choice of three riding modes:

- RAIN
- ROAD

- with riding modes Pro^{OE}
- DYNAMIC

Each of these modes produces perceptible differences in the way the motorcycle behaves. ASC/DTC can be switched off in each mode; the following explanations always relate to the switched-on system. The mode last selected is automatically reactivated after the ignition has been switched off and then on again.

Broadly speaking: The more dynamic the selected mode, the more ASC/DTC assistance is reduced.

Consequently, you must always bear the following in mind with regard to your selection of a ride mode: the more dynamic the setting, the greater the challenge to your riding skill.

Throttle response:

- In the RAIN mode: Restrained
- In the ROAD mode: Direct
- with riding modes Pro^{OE}
- In the DYNAMIC mode: Dynamic

RAIN mode

The ASC/DTC system intervenes early enough to prevent the rear wheel from spinning. On roads with a high to medium coefficient of friction (dry and wet asphalt to dry cobblestones), the motorcycle remains very stable; movements of the rear are clearly perceptible only on slippery roads (wet bitumen or wet cobblestones).

ROAD mode

ASC/DTC system intervention is later than in RAIN mode. On roads with a high to medium coefficient of friction (dry and

wet asphalt to dry cobblestones), the motorcycle remains stable. Slight rear-wheel drift is perceptible. Movements of the rear are clearly perceptible on slippery roads (wet bitumen or wet cobblestones).

- with riding modes Pro^{OE}

DYNAMIC mode

The DYNAMIC mode is the sportiest mode.

The ASC/DTC system intervenes even later, which means that, even on dry asphalt, drifting is possible under sharp acceleration when cornering.

ABS

- The rear wheel lifting assistant is active in all modes.
- ABS is tailored to on-road operation.

– In RAIN, ROAD and DYNAMIC riding modes, ABS Pro is fully available. The tendency of the motorcycle to straighten up when the brakes are applied with the machine banked for cornering is reduced to a minimum.

- with Dynamic ESA^{OE}

Dynamic ESA

Basic setting in:

- RAIN: ROAD
- ROAD: ROAD
- with riding modes Pro^{OE}
- DYNAMIC: DYNA

Changeover of the riding modes

The changeover of the functions in the engine control and the ASC/DTC is only possible if there is no drive torque at the rear wheel.

In order to achieve this state,

- the motorcycle must be at a standstill with the ignition switched on

or

- the throttle grip must be turned back and brakes must not be applied.

Dynamic Brake Control

- with riding modes Pro^{OE}

Dynamic Brake Control function

The Dynamic Brake Control function assists the rider during emergency braking.

Detection of emergency braking

- Emergency braking is detected when the front brake is actuated quickly and forcefully.

Behaviour during emergency braking

- If emergency braking is initiated at a speed above 10 km/h, the Dynamic Brake Control takes effect in addition to the ABS function.
- If partial braking at high brake pressure gradients is initiated, the Dynamic Brake Control increases the integral brake pressure on the rear wheel. The stopping distance shortens and controlled braking is possible.

Behaviour during accidental actuation of the throttle grip

- If, during emergency braking, the throttle grip is accidentally actuated (grip position > 5 %), the actual braking effect caused by the Dynamic Brake Control is guaranteed by closing the gas. The effect of emergency braking is guaranteed.

- If, during the intervention of the Dynamic Brake Control, the gas is closed (throttle grip position < 5 %), the engine torque requested by the ABS brake system is restored.
- If emergency braking finishes and the throttle grip is still actuated, the Dynamic Brake Control will reduce the engine torque to the driver's choice in a controlled manner.

- with US authority^{OE}



NOTICE

The function of the Dynamic Brake Control is switched off at the same time as the ABS is switched off. ◀

Tyre pressure control (RDC)

– with tyre pressure control (RDC)^{OE}

Function

A sensor integrated into each tyre measures the air temperature and the air pressure inside the tyre and transmits this information to the control unit. The sensors are fitted with a centrifugal-force tripswitch which allows the measured values to be transmitted after the minimum speed is exceeded the first time.

 Minimum speed for transmission of the RDC measured values:

min 10 km/h

The display shows "--" for each tyre until the tyre pressure signal is received for the first time. The sensors continue to transmit the

measured-value signals for some time after the vehicle comes to a stop.

 Time for transmission of measured values after vehicle comes to a stop:

min 15 min

An error message is issued if wheels without sensors are fitted to a vehicle equipped with an RDC control unit.

Tyre pressure ranges

The RDC control unit distinguishes between three tyre pressure ranges matched to the vehicle:

- Filling pressure within the permissible tolerance
- Filling pressure in the limit range of the permissible tolerance
- Filling pressure outside permitted tolerance

Temperature compensation

Tyre pressure is a temperature-sensitive variable: pressure increases as tyre-air temperature rises and decreases as tyre-air temperature drops. Tyre-air temperature depends on ambient temperature as well as on the style of riding and the duration of the ride.

 The tyre-pressure readings in the multifunction display are temperature-compensated and are always referenced to the following tyre-air temperature:

20 °C

The air lines available to the public in petrol stations and motorway service areas have gauges that do not compensate for temperature; the reading shown by a gauge of this nature is the temperature-dependent tyre-

air pressure. In most instances, therefore, these gauge readings will not tally with the pressures shown by the multifunction display.

Pressure adaptation

Compare the RDC value on the multifunction display with the value in the table on the back cover of the Rider's Manual. Then use the air-line gauge at a service station to compensate for the difference between the RDC reading and the value in the table.

 Example
According to the Rider's Manual, the tyre pressure should be:
2.5 bar

 Example
The multifunction display shows the following reading:
2.3 bar
So pressure is low by:
0.2 bar
The gauge on the air line shows:
2.4 bar
You must now increase tyre pressure until the value is:
2.6 bar

Shift assistant

– with shift assistant Pro^{OE}

Shift assistant Pro

Your vehicle is equipped with a Pro shift assistant, a system originally developed for racing and now adapted for touring. It

permits upshifts and downshifts without declutching or closing the throttle in virtually all load and rpm ranges.

Advantages

- 70-80 % of all gearshifts on a trip can be done without using the clutch.
- Less relative movement between rider and passenger because the shift pauses are shorter.
- It is not necessary to close the throttle valve when shifting under acceleration.
- When braking and downshifting (throttle valve closed), engine speed is adjusted by blipping the throttle.
- Shift time is shorter than a gearshift with clutch actuation.

In order for the system to identify a gearshift request, the rider has to move the gearshift lever from its idle position in the desired direction against the spring force through a certain "over-travel" at ordinary speed or rapidly and keep the gearshift lever in this position until the gearshift is completed. It is not necessary to increase the force applied to the shift lever while shifting is in progress. Once the gearshift has completed the shift lever has to be fully released before another gearshift with the Pro shift assistant can take place. When shifting gears with the Pro shift assistant, the rider has to keep load state (throttle grip position) constant before and during the gearshift. A change in the position of the throttle grip during a gearshift can cause the function to abort and/or lead to a missed shift. The Pro shift assistant provides

no assistance for the gearshift if the rider declutches.

Downshifting

- Downshifting is assisted until maximum rpm for the target gear to be selected is reached. This prevents overrevving.



Maximum engine speed

max 9000 min⁻¹

Upshifting

- Upshifting is only possible when the current speed is higher than the respective release threshold of the next higher gear.
- This prevents the engine from dropping below idle speed.



Idle speed

1050 min⁻¹ (Engine at regular operating temperature)



Release thresholds

1st gear

min 1350 min⁻¹

2nd gear

min 1400 min⁻¹

3rd gear

min 1450 min⁻¹

4th gear

min 1500 min⁻¹

5th gear

min 1550 min⁻¹

6th gear

min 1600 min⁻¹

Hill Start Control

Hill Start Control function

Hill Start Control assistant prevents the motorcycle from rolling backwards uncontrolled on gradients by intervening specifically with the ABS brake system without the driver having to constantly operate the brake lever. Pressure in the rear brake system is built up when Hill Start Control is activated in order to keep the motorcycle stationary on an incline.

The brake pressure in the brake system is dependent on the gradient.

Effect of an incline on brake pressure and drive-off behaviour

- If the motorcycle is stopped on a gentle incline, only low brake pressure is built up. In this case, the brakes are quickly released when driving off. The

motorcycle can be moved off more gently. It is not necessary to turn the throttle grip again.

- If the motorcycle is stopped on a steep incline, high brake pressure is built up. In this case, the brakes take longer to release when driving off. More torque is required for driving off which also requires the rider to turn the throttle grip again.

Behaviour when the motorcycle rolls or slips

- If the motorcycle rolls when Hill Start Control is activated, the brake pressure is increased.
- If the rear wheel slips, the brake is released again after approx. 1 m. This prevents, for example, slipping due to a blocked rear wheel.

Releasing brake when stopping the engine or timeout

Hill Start Control is deactivated when the engine is stopped using the emergency-off switch, when the side stand is folded out or after timeout (10 minutes). In addition to the indicator and warning lights, the rider should be made aware that Hill Start Control has been deactivated by the following behaviour:

Brake warning jolt

- The brake is released briefly and reactivated immediately.
- This creates a jolt which the rider feels.
- The ABS brake system with partially integral function sets a speed of approx. 1-2 km/h.
- The rider must brake the motorcycle manually.
- After two minutes, or when the brake is actuated, Hill Start

Control is completely deactivated.



NOTICE

The holding pressure is released immediately without a brake warning jolt as soon as the ignition is switched off.◀

Engine run-on circuit

– with Keyless Ride^{OE}

Engine run-on circuit function

The vehicle is secured against misuse when the engine is running with the help of the engine run-on circuit. This allows the rider to step away from the vehicle when the battery is being charged and consumers (e.g. light signals) are switched on. The side stand must be folded out with the engine running at idle for this.

The vehicle is secured against being ridden away and the engine continues to run if the rider walks away from the vehicle carrying the radio-operated key.

It can be ridden again when the key is detected and the side stand is folded in.

The engine will switch off if the key is not in frequency range when the side stand is folded in.

Maintenance

General instructions.....	152
Standard toolkit	152
Service toolkit.....	152
Front-wheel stand	153
Engine oil	154
Brake system	155
Clutch	160
Coolant	160
Tyres	162
Rims and tyres.....	162
Wheels	163
Silencer.....	169
Lighting.....	171
Jump-starting.....	176
Battery.....	177

Fuses	185
Diagnostic connector	187

General instructions

The "Maintenance" chapter describes straightforward procedures for checking and replacing certain wear parts.

Special tightening torques are listed as applicable. The tightening torques for the threaded fasteners on your vehicle are listed in the section entitled "Technical data".

Further information on maintenance and repair work is available from your BMW Motorrad authorised dealer in the form of a DVD.

Some of the work requires special tools and a thorough knowledge of the technology involved. If you are in doubt, consult a specialist workshop, preferably your authorised BMW Motorrad dealer.

Standard toolkit



- 1** Screwdriver handle
- 2** Reversible screwdriver blade
 - Phillips PH1 and Torx T25
 - Removing front seat (➡ 100).
 - Removing and installing body panels.
- 3** Tool for oil cap
 - Topping up the engine oil (➡ 155).
 - Removing rear seat (➡ 101).
 - Install the rear seat (➡ 102).

- 4** Open-ended spanner
Width across flats 8/10

Service toolkit

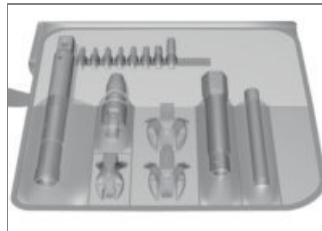

BMW Motorrad has assembled a service toolkit that is ideal for carrying out extended service work (e.g. removing and installing wheels) on this motorcycle. You can obtain the tools set from your authorised BMW Motorrad dealer.

Front-wheel stand

Installing the front-wheel stand

ATTENTION

Use of the BMW Motorrad front wheel stand without accompanying use of centre stand or auxiliary stand

Risk of damage to parts if vehicle topples

- Place the motorcycle on its centre stand or another auxiliary stand before lifting the front wheel with the BMW Motorrad front-wheel stand. ◀
- Make sure the ground is level and firm and place the motorcycle on its centre stand.
- Use basic stand with front-wheel adapter. The basic stand and its accessory components are available from your

BMW Motorrad authorised dealer.

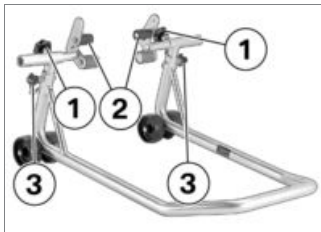

- Loosen mounting bolt **1**.
- Push the two adapters **2** apart until the front forks fit between them.
- Use retaining pins **3** to set the front-wheel stand to the desired height.
- Centre the front-wheel stand relative to the front wheel and push it against the front axle.

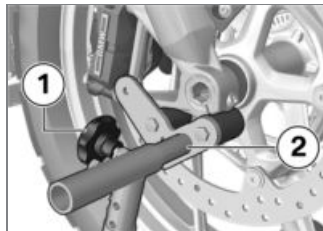

- Align the two adapters **2** so that the front forks are securely seated.
- Tighten mounting bolt **1**.

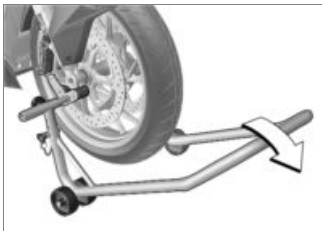

ATTENTION

Centre stand retracts if motorcycle is lifted too high

Risk of damage to parts if vehicle topples

- When raising the vehicle, make sure that the centre stand remains on the ground.◀
- Apply uniform pressure to push the front-wheel stand down and raise the motorcycle.

Engine oil

Checking engine oil level

NOTICE

Incorrect interpretation of the oil capacity is possible because the oil level is temperature-dependent.◀

- Make sure the ground is level and firm and place the motorcycle (at operating temperature) on its centre stand.
- Let engine idle until the fan turns on.
- Switch off the engine when it is at operating temperature.
- Wait five minutes for the oil to drain into the oil pan.

NOTICE

To protect the environment, BMW Motorrad recommends occasionally checking the

engine oil after a journey of at least 50 km.◀

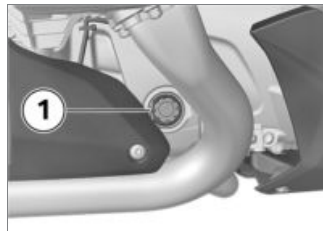

- Check the oil level in the display **1**.

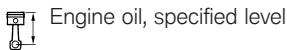

Engine oil, specified level
between MIN and MAX marks

If the oil level is below the MIN mark:

- Topping up the engine oil (►► 155).

If the oil level is above the MAX mark:

- Have the oil level corrected by a specialist workshop, preferably an authorised BMW Motorrad dealer.

Topping up the engine oil

- Place the motorcycle on its stand on firm, even ground.



- Wipe the area around the oil filler opening clean.
- Use oil filler cap tool **1** to remove cap **2** from the oil filler opening.
- Engage oil filler cap tool **1** in cap **2** of the oil filler opening and turn the tool anti-clockwise to remove the cap.

ATTENTION

Use of insufficient engine oil or too much engine oil

Engine damage

- Always make sure that the oil level is correct.◀
- Top up the engine oil to the specified level.

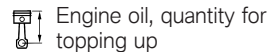

Engine oil, quantity for topping up
max 0.8 l (Difference between MIN and MAX)

- Checking engine oil level (►► 154).
- Install cap **2** of the oil filler opening.

Brake system

Checking function of brakes

- Pull the front brake lever.

- » The pressure point must be clearly perceptible.
- Press the footbrake lever.
- » The pressure point must be clearly perceptible.

If pressure points are not clearly perceptible:



ATTENTION

Work on brake system not in compliance with correct procedure

Risk to operational reliability of the brake system

- Have all work on the brake system undertaken by trained and qualified specialists. ◀
- Have the brakes checked by a specialist workshop, preferably an authorised BMW Motorrad dealer.

Checking front brake pad thickness

- Place the motorcycle on its stand on firm, even ground.



- Visually inspect the left and right brake pads to ascertain their thickness. Viewing direction: between wheel and front suspension toward brake pads **1**.

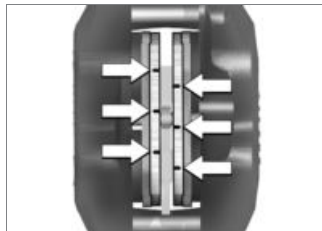

Brake-pad wear limit, front

1.0 mm (Friction pad only, without backing plate. The wear indicators (grooves) must be clearly visible.)

If the wear indicating marks are no longer clearly visible:

WARNING

Brake-pad thickness less than permissible minimum

Diminished braking effect, damage to the brakes

- In order to ensure the dependability of the brake system, do not permit the brake pads to wear past the minimum permissible thickness. ◀
- Have the brake pads replaced by a specialist workshop, preferably an authorised BMW Motorrad Retailer.

Checking rear brake pad thickness

- Place the motorcycle on its stand on firm, even ground.

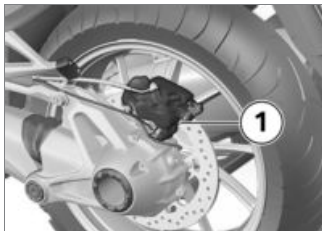

- Visually inspect the brake pads to ascertain their thickness. Viewing direction: from the rear towards the brake pads **1**.



 Brake-pad wear limit, rear

1.0 mm (Friction pad only, without backing plate.)

If the wear limit has been reached:

WARNING

Brake-pad thickness less than permissible minimum

Diminished braking effect, damage to the brakes

- In order to ensure the dependability of the brake system, do not permit the brake pads to wear past the minimum permissible thickness. ◀
- Have the brake pads replaced by a specialist workshop, preferably an authorised BMW Motorrad Retailer.

Checking brake-fluid level, front brakes

WARNING

Not enough brake fluid in brake fluid tank

Considerably reduced braking power due to air in the brake system

- Adjust the riding mode immediately until the fault is rectified.
- Check the brake-fluid level at regular intervals. ◀
- Make sure the ground is level and firm and place the motorcycle on its centre stand.
- Move the handlebars to the straight-ahead position.

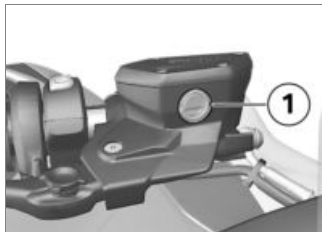

- Check the brake fluid level in front reservoir **1**.

NOTICE

Wear of the brake pads causes the brake fluid level in the reservoir to sink. ◀



 Brake fluid level, front

Brake fluid, DOT4

It is impermissible for the brake fluid level to drop below the MIN mark. (Brake-fluid reservoir horizontal, motorcycle upright)

If the brake fluid level drops below the permitted level:

- Have the defect rectified as quickly as possible by a specialist workshop, preferably an authorised BMW Motorrad dealer.

Checking the brake-fluid level, rear brakes

WARNING

Not enough brake fluid in brake fluid tank

Considerably reduced braking power due to air in the brake system

- Adjust the riding mode immediately until the fault is rectified.
- Check the brake-fluid level at regular intervals.◀
- Make sure the ground is level and firm and place the motorcycle on its centre stand.



- Check the brake fluid level in rear reservoir **1**.

NOTICE

Wear of the brake pads causes the brake fluid level in the reservoir to sink.◀



 Brake fluid level, rear

Brake fluid, DOT4

It is impermissible for the brake fluid level to drop below the MIN mark. (Brake-fluid reservoir horizontal, motorcycle upright)

If the brake fluid level drops below the permitted level:

- Have the defect rectified as quickly as possible by a specialist workshop, preferably an authorised BMW Motorrad dealer.

Clutch

Checking clutch function

- Pull the clutch lever.
 - » The pressure point must be clearly perceptible.
- If the pressure point is not clearly perceptible:

- Have the clutch checked by a specialist workshop, preferably an authorised BMW Motorrad dealer.

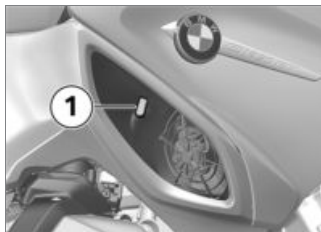

- Check the coolant level in expansion tank **1**.

Coolant

Check coolant level

- Place the motorcycle on its stand on firm, even ground.
- Allow the engine to cool down.



Coolant, specified level

Between MIN and MAX marks on the expansion tank (Engine cold)

If the coolant drops below the permitted level:

- Have the defect rectified as quickly as possible by a specialist workshop, preferably an authorised BMW Motorrad Retailer.

Top up coolant

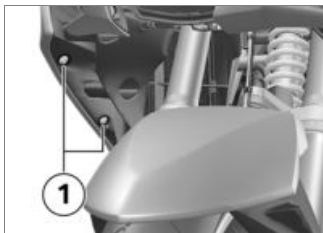

- Remove screws **1**.

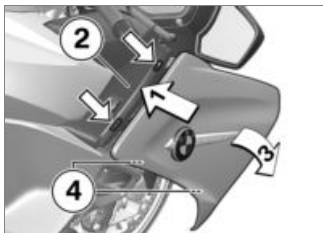

- Pull side trim panel **3** forwards and outwards.
 - » Tabs **4** are pulled from the grommets.

- Pull side trim panel **1** upwards from side section **2** and remove, taking care with the tabs (**arrowed**).



- Open cap **1** of the coolant expansion tank and top up the coolant to the specified level.
- Check coolant level (▮▮▮ 160).
- Close the cap of the coolant expansion tank.

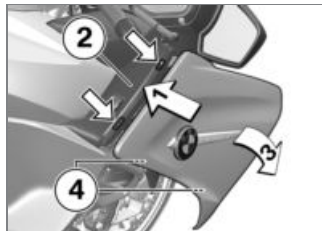

- Hold side panel **1** ready with the lugs in position at side trim **2**.
- Pivot side panel **3** inward.
 - » Lugs **4** are pressed into the grommets.

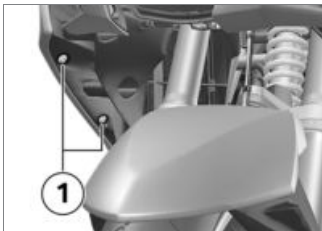

- Install screws 1.

Tyres

Checking tyre pressure

WARNING

Incorrect tyre pressure

Impaired handling characteristics of the motorcycle, shorter useful tyre life

- Always check that the tyre pressures are correct.◀

WARNING

Tendency of valve inserts installed vertically to open by themselves at high riding speeds

Sudden loss of tyre pressure

- Install valve caps fitted with rubber sealing rings and tighten firmly.◀
- Make sure the ground is level and firm and place the motorcycle on its stand.
- Check tyre pressures against the data below.



Tyre pressure, front

2.5 bar (tyre cold)



Tyre pressure, rear

2.9 bar (tyre cold)

If tyre pressure is too low:

- Correct tyre pressure.

Rims and tyres

Checking rims

- Make sure the ground is level and firm and place the motorcycle on its stand.
- Visually inspect the rims for defects.
- Have any damaged rims inspected by a specialist workshop and replaced if necessary, preferably by an authorised BMW Motorrad dealer.

Checking tyre tread depth



Riding with badly worn tyres

Risk of accident due to impaired handling

- If applicable, have the tyres changed in good time before they wear to the minimum tread depth permitted by law. ◀
- Make sure the ground is level and firm and place the motorcycle on its stand.
- Measure the tyre tread depth in the main tread grooves with wear marks.



Wear indicators are built into the main profile grooves on each tyre. The tyre is worn out when the tyre tread has worn down to the level of the marks. The locations of the marks are indicated on the edge of the tyre, e.g.

by the letters TI, TWI or by an arrow. ◀

If the tyre tread is worn to minimum:

- Replace tyre or tyres, as applicable.

Wheels

Tyre recommendation

For each size of tyre, BMW Motorrad tests and classifies as roadworthy certain makes. BMW Motorrad cannot assess the suitability or provide any guarantee of road safety for other tyres.

BMW Motorrad recommends using only tyres tested by BMW Motorrad.

Detailed information is available from your authorised BMW Motorrad dealer or in the internet at:

bmw-motorrad.com

Effect of wheel size on chassis and suspension control systems

Wheel size is very important as a parameter for the frame and suspension control systems ABS and ASC/DTC. In particular, the diameter and the width of the vehicle's wheels are programmed into the control unit and are fundamental to all calculations. Any change in these influencing variables, caused for example by a switch to wheels other than those installed ex-works, can have serious effects on the performance of the control systems. The sensor rings are essential for correct road-speed calculation, and they too must match the motorcycle's control systems and consequently cannot be changed.

If you decide that you would like to fit non-standard wheels to your motorcycle, it is very im-

portant to consult a specialist workshop beforehand, preferably an authorised BMW Motorrad dealer. In some cases, the data programmed into the control units can be changed to suit the new wheel sizes.

RDC sticker

- with tyre pressure control (RDC)^{OE}

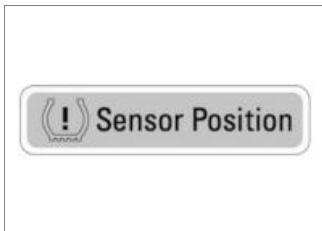

ATTENTION

Tyre removal not in compliance with correct procedure

Damage to RDC sensors

- Be sure to explain to the specialist workshop or authorised BMW Motorrad dealer that the wheel is fitted with an RDC sensor. ◀

On motorcycles equipped with RDC, a corresponding sticker can be found on the wheel rim at the position of the RDC sensor. When changing tyres, ensure that the RDC sensor is not damaged. Inform the authorised BMW Motorrad Retailer or the specialist workshop about the RDC sensor.

Removing front wheel

- Make sure the ground is level and firm and place the motorcycle on its centre stand.

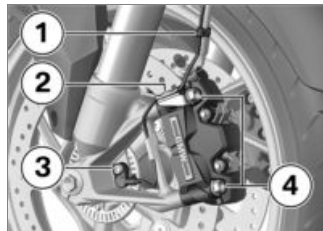

- Remove ABS sensor cable from the holding clips **1** and **2**.
- Remove screw **3** and remove the ABS sensor from the bore hole.
- Mask off the parts of the wheel rim that could be scratched in the process of removing the brake calipers.

ATTENTION

Unwanted inward movement of the brake pads

Component damage on attempt to install the brake caliper or be-

cause brake pads have to be forced apart

- Do not operate the brakes with a brake caliper not correctly secured.◀
- Remove mounting bolts **4** of the left and right brake calipers.

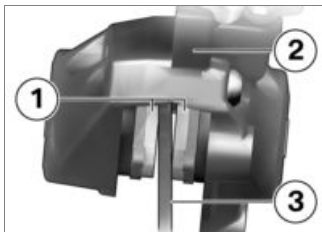

- Force the brake pads **1** slightly apart by rotational movement of the brake caliper **2** against brake disc **3**.
- Carefully pull the brake calipers back and out until clear of the brake discs.

- Lift the front of the motorcycle until the front wheel is clear of the ground, preferably using a BMW Motorrad front-wheel stand.
- Installing the front-wheel stand (► 153).

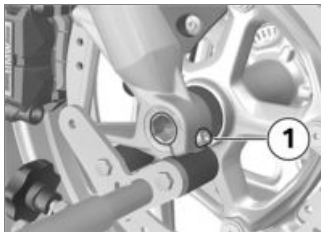

- Undo right axle clamping screw **1**.

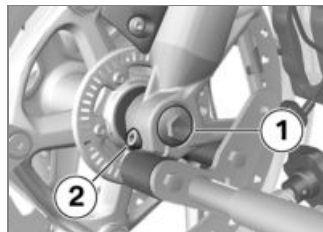

- Remove the bolt **1**.
- Undo left axle clamping screw **2**.
- Press quick-release axle slightly toward the inside, so as to be better able to grip it on the right-hand side.

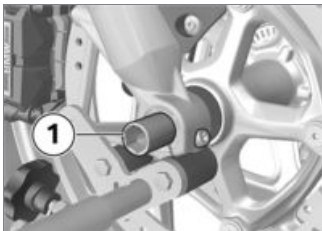

- Withdraw quick-release axle **1**, support the front wheel when doing this.
- Set down front wheel and roll forwards out of the front suspension.

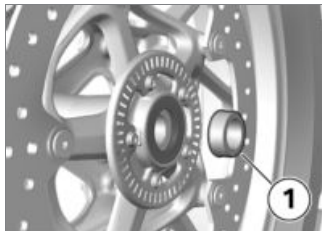

- Remove spacer bush **1** from the wheel hub.

Installing front wheel

WARNING

Use of a non-standard wheel

Malfunctions during ABS and ASC/DTC intervention

- See the information on the effect of wheel size on the ABS and ASC/DTC systems at the start of this chapter.◀



ATTENTION

Tightening threaded fasteners to incorrect tightening torque

Damage, or threaded fasteners work loose

- Always have the security of the fasteners checked by a specialist workshop, preferably an authorised BMW Motorrad dealer.◀

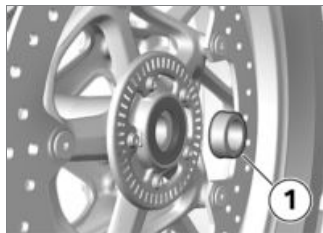

- Insert spacer bush **1** into the wheel hub on the left-hand side.



ATTENTION

Front wheel installed wrong way round

Risk of accident

- Note direction-of-rotation arrows on tyre or rim. ◀
- Roll the front wheel into position between the front suspension.

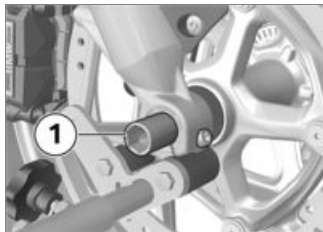

- Lift front wheel and install quick-release axle **1**.
- Remove front-wheel stand and firmly compress front forks

several times. Do not operate handbrake lever.

- Installing the front-wheel stand (▶▶ 153).

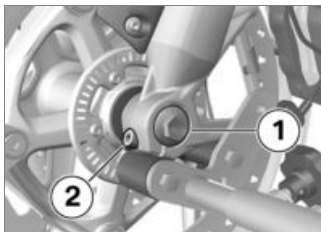

- Install bolt **1** and tighten to specified torque. Counter-hold quick-release axle on the right-hand side.

Quick-release axle in telescopic forks

30 Nm

- Tighten left axle clamping screw **2** to specified torque.



Bottom fork bridge to slider tube

19 Nm

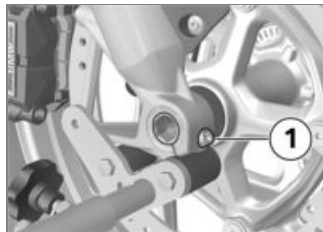

- Tighten right axle clamping screw **1** to specified torque.



Clamping screw for quick-release axle in telescopic fork

19 Nm

- Remove the front-wheel stand.

- Position left and right brake calipers on the brake discs.

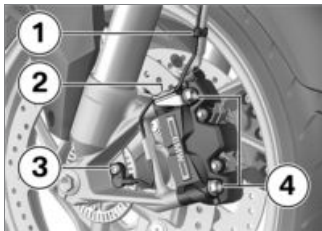

- Install mounting bolts **4** on left and right and tighten to specified torque.



Radial brake caliper on telescopic forks

38 Nm

- Remove the adhesive tape from the wheel rim.



WARNING

Brake pads not lying against the brake disc

Risk of accident due to delayed braking effect.

- Before driving, check that the brakes respond without delay. ◀
- Operate the brake several times until the brake pads are bedded.
- Insert ABS sensor line into the holding clips **1** and **2**.
- Insert the ABS sensor into the bore hole and fit screw **3**.



Wheel-speed sensor to fork leg

Joining compound: Micro-encapsulated or medium-strength thread-locking compound

8 Nm

Removing rear wheel

- Pivot silencer outwards (▶▶ 169).

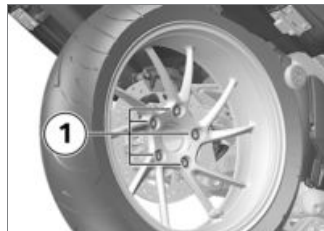

- Engage first gear.
- Remove studs **1** from the rear wheel, while supporting the wheel.
- Roll the rear wheel out toward the rear.

Installing the rear wheel

WARNING

Use of a non-standard wheel

Malfunctions during ABS and ASC/DTC intervention

- See the information on the effect of wheel size on the ABS and ASC/DTC systems at the start of this chapter.◀

ATTENTION

Tightening threaded fasteners to incorrect tightening torque

Damage, or threaded fasteners work loose

- Always have the security of the fasteners checked by a specialist workshop, preferably an authorised BMW Motorrad dealer.◀

- Seat the rear wheel on the rear-wheel adapter.

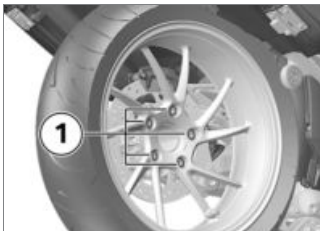

- Install wheel studs **1** and tighten to specified torque.

 Rear wheel to wheel flange

Tightening sequence: tighten in diagonally opposite sequence

60 Nm

- Securing silencer (➡ 170).

Silencer

Pivot silencer outwards

– with weather protection^{OE}

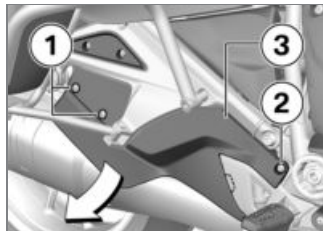

- Remove the bolts **1**.
- Remove the bolt **2**.
- Remove weather protection **3** in the direction of the arrow.◀

CAUTION

Hot exhaust system

Risk of burn injury

- Do not touch a hot exhaust system.◀

- Place the motorcycle on its side stand on firm, level ground.
- Allow the silencer to cool.

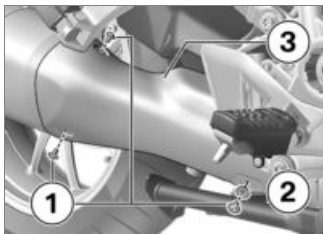

- Remove front bolts **1** and washer **2**.
- Remove the silencer cover **3**.

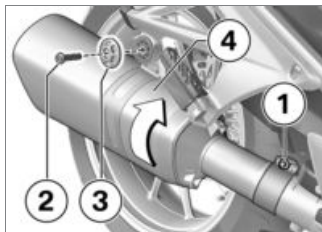

- Detach bolt **1** from the clamp.
- Remove bolt **2** and lock washer **3**.
- Turn silencer **4** **clockwise** and outwards.

Securing silencer



ATTENTION

Tightening threaded fasteners to incorrect tightening torque

Damage, or threaded fasteners work loose

- Always have the security of the fasteners checked by a

specialist workshop, preferably an authorised BMW Motorrad dealer. ◀

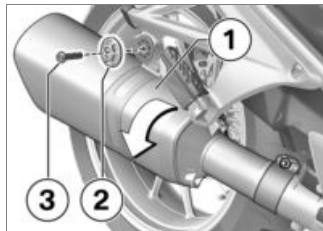

- Turn silencer **1** anti-clockwise until it sits at the passenger footrest bracket.
- Fit shim **2** and screw **3**.



Silencer to rear frame

19 Nm

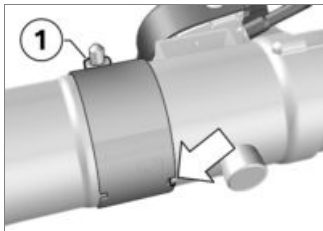

- Slide clamp **1** as far forwards as possible and position it with the recess in the lug (**arrow**).
- Tighten the clip.



Clamp, manifold-rear silencer

28 Nm

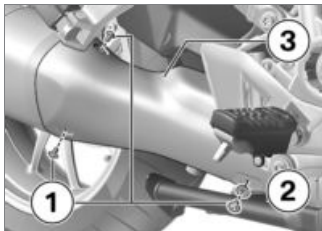

- Position silencer cover **3**.
- Install screws **1**, with a shim **2** at the front.

– with weather protection^{OE}

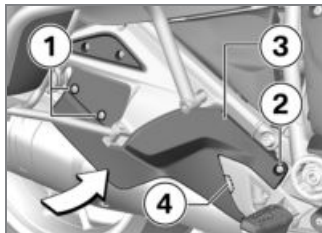

- Insert weather protection **3** in the direction of the arrow and attach in the bracket **4**.
- Fit bolt **2**.
- Fit bolts **1**.<

Lighting

Replacing bulb for low-beam headlight



NOTICE

The arrangements of the connectors and the light sources

may differ from the following figures. ◀

- Make sure the ground is level and firm and place the motorcycle on its stand.
- Switch off the ignition.



- Remove cover **1** by turning it counter-clockwise to replace the bulb for the low-beam headlight.



- Disconnect plug **1**.



- Disengage spring clip **1** and swing it aside.
- Remove bulb **2**.

- Replace the defective bulb.



Bulbs for the low-beam headlight

H7 / 12 V / 55 W

- Hold the bulb by the base only, in order to keep the glass free of foreign matter.

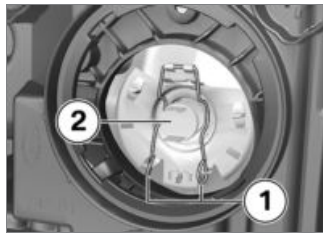

- Insert bulb **2**, making sure that the tab is correctly positioned.



NOTICE

The bulb might face in a direction other than that shown here. ◀

- Engage spring clip **1** in the catch.



- Connect plug **1**.



- Insert cover **1** and turn it clockwise to install.

Replacing bulb for high-beam headlight

NOTICE

The description below steps you through the procedure for replacing the left bulb. The procedure for working on the right side is the same. ◀

- Make sure the ground is level and firm and place the motorcycle on its stand.
- Switch off the ignition.

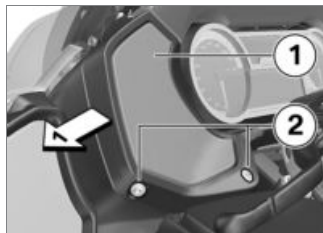

- Remove screws **2**.

- Ease speaker cover **1** to the left to remove.

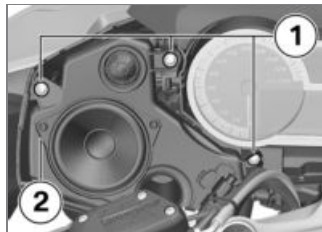

- Remove screws **1**.
- Carefully remove speaker unit **2**, noting the plug.

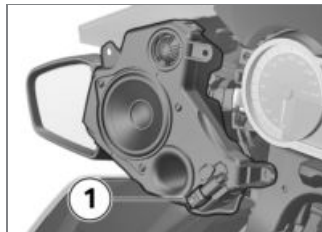

- Disconnect plug **1**.



- Pull the tab to remove cover **1**.



- Disconnect plug **1**.



- Release spring clip **1** at left and right and swing it open.
- Remove bulb **2**.
- Replace the defective bulb.

	Bulb for high-beam
	headlight

H1 / 12 V / 55 W

- Hold the bulb by the base only, in order to keep the glass free of foreign matter.



- Install bulb **2**, making sure that the tab is correctly positioned.

NOTICE

The bulb might face in a direction other than that shown here. ◀

- Insert spring clip **1**.



- Connect plug **1**.

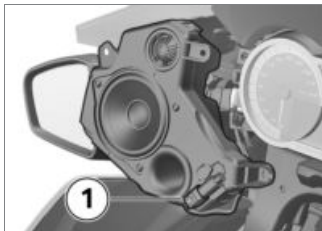

- Connect plug **1**.

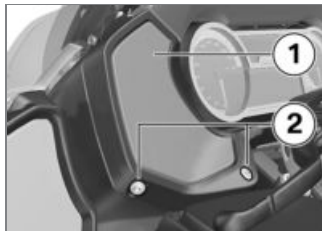

- Hold speaker cover **1** in position and install screws **2**.



- Install cover **1**.

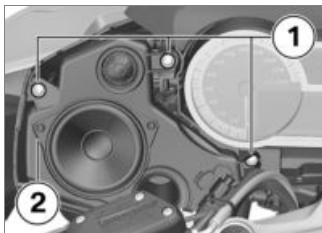

- Seat speaker unit **2** in the mount.
- Install screws **1**.

Replacing LED rear light

The LED rear light can be replaced only as a complete unit.

- Consult a specialist workshop, preferably an authorised BMW Motorrad dealer.

Replacing LED turn indicators

- LED turn indicators can be replaced only as a complete unit. Consult a specialist workshop, preferably an authorised BMW Motorrad dealer.

Waveguide rings, replacing

- with daytime riding light^{OE}
- with Headlight Pro^{OE}

- Waveguide rings are integrated into the headlight and can be replaced only together with the headlight. Consult a specialist workshop, preferably an authorised BMW Motorrad dealer.

Replacing the LED additional headlights

- with additional headlight^{OE}

The LED additional headlights can only be replaced in full; it is not possible to replace individual LEDs.

Consult a specialist workshop, preferably an authorised BMW Motorrad dealer.

Jump-starting



ATTENTION

Excessive current flowing when the motorcycle is jump-started

Wiring smoulders/ignites or damage to the on-board electronics

- If the motorcycle has to be jump-started connect the leads to the battery terminals; never attempt to jump-start the engine by connecting leads to the on-board socket.◀



ATTENTION

Contact between crocodile clips of jump leads and vehicle

Risk of short-circuit

- Use jump leads fitted with fully insulated crocodile clips at both ends.◀



ATTENTION

Jump-starting with a voltage greater than 12 V

Damage to the on-board electronics

- Make sure that the battery of the donor vehicle has a voltage rating of 12 V.◀
- Place the motorcycle on its stand on firm, even ground.
- Removing battery cover (▶▶ 179).
- When jump-starting the engine, do not disconnect the battery from the on-board electrical system.

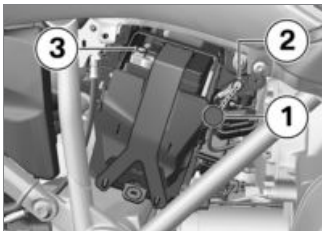

- Remove protective cap **1**.
- Connect the red jump lead to the positive battery connection point **2** of the drained battery and the positive terminal of the donor battery.
- Then connect one end of the black jump lead to the negative terminal of the donor battery and the other end to negative terminal **3** of the discharged battery.
- Run the engine of the donor vehicle during jump-starting.
- Start the engine of the vehicle with the discharged battery in the usual way; if the en-

gine does not start, wait a few minutes before repeating the attempt in order to protect the starter motor and the donor battery.

- Allow both engines to idle for a few minutes before disconnecting the jump leads.
- Disconnect the jump lead from the negative terminals first, then disconnect the second lead from the positive terminals.



NOTICE

Do not use proprietary start-assist sprays or other products to start the engine. ◀

- Install the protective cap.
- Installing the battery cover (▶▶ 181).

Battery

Maintenance instructions

Correct upkeep, recharging and storage will prolong the life of the battery and are essential if warranty claims are to be considered.

Compliance with the points below is important in order to maximise battery life:

- Keep the surface of the battery clean and dry.
- Do not open the battery.
- Do not top up with water.
- Be sure to read and comply with the instructions for charging the battery on the following pages.
- Do not turn the battery upside down.

**ATTENTION****On-board electronics (e.g. clock) draining connected battery**

Battery is deep-discharged; this voids the guarantee

- Connect a float charger to the battery if the motorcycle is to remain out of use for more than four weeks.◀

**NOTICE**

BMW Motorrad has developed a float charger specially designed for compatibility with the electronics of your motorcycle. Using this charger, you can keep the battery charged during long periods of disuse, without having to disconnect the battery from the motorcycle's on-board systems. You can obtain additional information from your authorised BMW Motorrad dealer.◀

Charge battery when connected**ATTENTION****Charging the battery that is connected to the vehicle via the battery terminals**

Damage to the on-board electronics

- Disconnect the battery at the battery terminals before charging.◀

**ATTENTION****Recharging a fully discharged battery via the power socket or extra socket**

Damage to the vehicle electronics

- If a battery has discharged to the extent that it is completely flat (battery voltage less than 12 V, indicator lights and multifunction display remain off when the ignition is switched

on) always charge the **disconnected** battery with the charger connected directly to the battery terminals.◀

**ATTENTION****Unsuitable chargers connected to a socket**

Damage to charger and vehicle electronics

- Use suitable BMW chargers. The suitable charger is available from your authorised BMW Motorrad dealer.◀
- Charge via the charging socket, with the battery connected to the motorcycle's on-board electrical system.

**NOTICE**

The motorcycle's on-board electronics know when the battery is fully charged. The on-board socket is switched off when this happens.◀

- Comply with the operating instructions of the charger.

NOTICE

If you are unable to charge the battery through the on-board socket, you may be using a charger that is not compatible with your motorcycle's electronics. If this happens, charge the battery directly at the terminals of the battery that is disconnected from the vehicle.◀

Charging battery when disconnected

- Charge the battery using a suitable charger.
- Comply with the operating instructions of the charger.
- Once the battery is fully charged, disconnect the charger's terminal clips from the battery terminals.

NOTICE

The battery has to be recharged at regular intervals in the course of a lengthy period of disuse. See the instructions for caring for your battery. Always fully recharge the battery before restoring it to use.◀

Removing battery

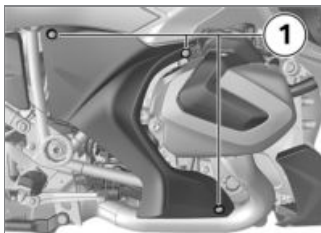

- Switch off the ignition.
- Remove screws **1**.
- Remove battery cover.

- with anti-theft alarm (DWA)^{OE}
- If applicable, switch off the anti-theft alarm (DWA).◀



- Disconnect battery negative lead **1** and disengage rubber strap **2**.



- Pull retaining plate in position **1** outwards and remove in an upward direction.
- Slightly lift the battery and ease it clear of the holder until the battery positive terminal is accessible.

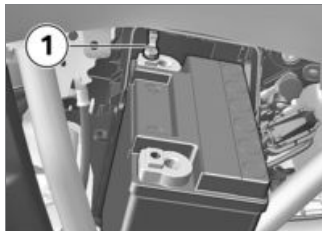

- Disconnect battery negative lead **1** and remove the battery.
» The battery is removed.

Installing battery

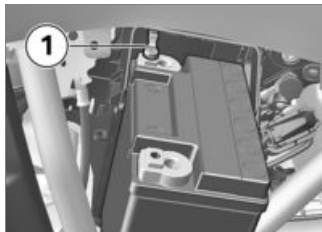

- Secure battery positive lead **1**.



NOTICE

The fuse for the alternator regulator can blow if the 12 V battery is installed incorrectly or if the terminals are swapped (e.g. when using a starting aid).◀

- Push battery into the mounting.

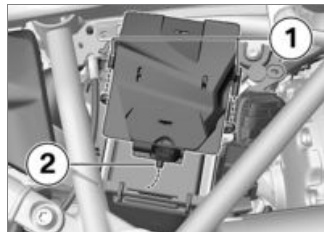

- First push the retaining plate under the battery at position **1** and then seat it in mounts **2**.



- Secure battery negative lead **1**.
- Secure the battery with rubber strap **2**.

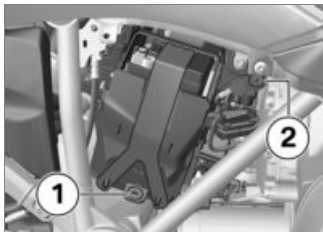

- Insert battery cover into the fixture **1** and press into the fixtures **1** and **2**.

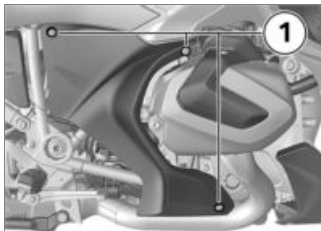

- Install screws **1**.
- Switch on the ignition.
- Adjust the time and date in the *Settings - Clock and Settings - Date* menu.

Removing auxiliary battery

– with anti-theft alarm (DWA)^{OE}

- Kill switch in operating position (run).
- Switch on the ignition.
 - » Turn indicators flash once.
 - » Confirmation tone sounds once (if programmed).

- » DWA has been switched off.
- with central locking system^{OE} or
- with Keyless Ride^{OE}

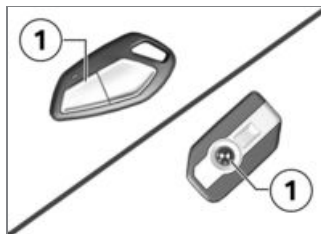

- Press button **1** of the radio-operated key once.



NOTICE

The alarm function is reactivated after 30 seconds if "activation after ignition off" has been selected if the alarm function is deactivated using the radio-operated key and the ignition is not then switched on. ◀

- » Turn indicators flash once.
- » Confirmation tone sounds once (if programmed).
- » DWA has been switched off.

– with single seat with radio transceiver box^{OE}

- Open radio transceiver box (➡ 195).
- Emergency unlocking of the radio transceiver box if electrical unlocking has failed (➡ 195).
- Removing front seat (➡ 100).

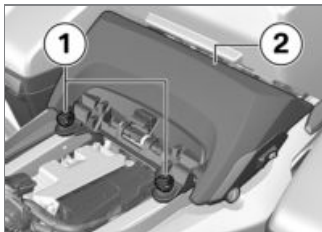

- Remove screws **1**.
- Pull the seat wedge **2** towards the front.

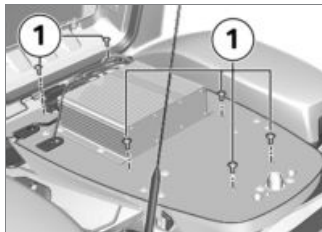

- Remove screws **1**.

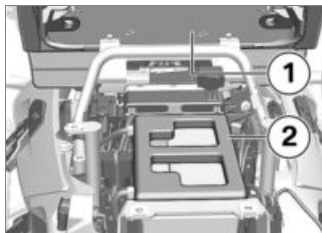

- Raise two-way radio box **1** and secure it in the raised position by inserting a suitable object.
- Remove battery cover **2**.

– without single seat with radio transceiver box^{OE}

Requirement

Double motorcycle seat is installed.

- Removing rear seat (➡ 101).

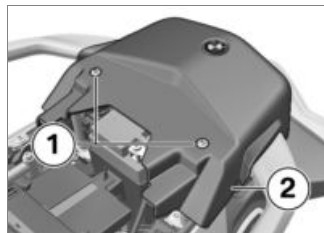

- Remove screws **1**.

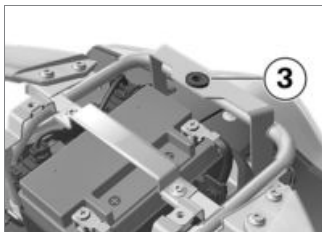

- Pull the battery cover **2** from the grommet **3** towards the top and remove it.

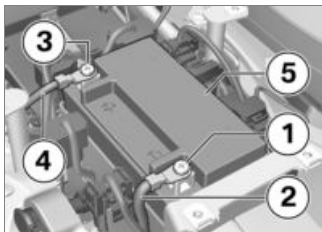

- Remove the bolt **1** and loosen the battery earth lead **2**.
- Remove the bolt **3** and loosen the positive battery cable **4**.

- Remove auxiliary battery **5**.

Installing auxiliary battery

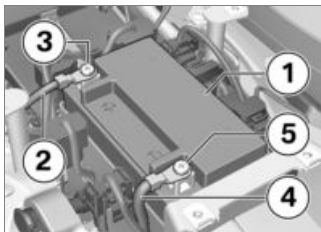

- Install the auxiliary battery **1**.
- Position the positive battery cable **2** and install the bolt **3**.
- Position the battery earth lead **4** and install the bolt **5**.

- without single seat with radio transceiver box^{OE}

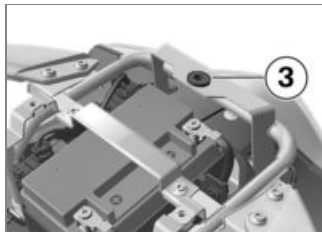

- Insert the battery cover into the grommet **3**.

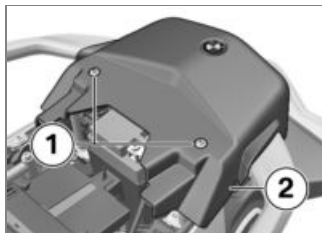

- Secure the battery cover **2** using bolts **1**.

- Install the rear seat (▣▣▣ 102).<
- with single seat with radio transceiver box^{OE}

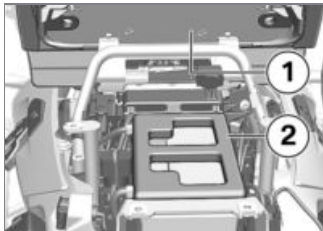

- Install the battery cover **2**.
- Lower the radio transceiver box **1**.

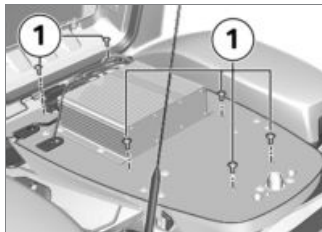

- Install screws **1**.<



- Insert seat wedge **2**.
- Install screws **1**.
- Installing front seat (▣▣▣ 100).

- Close the lid and press it shut until the latch engages. Check that nothing is trapped between the lid and the case.

- with anti-theft alarm (DWA)^{OE}

- Switching on ignition (▣▣▣ 54).
- DWA Adapting (▣▣▣ 97).
- Switch off the ignition.

- » If the alarm system is activated, then the alarm system will be automatically activated when the ignition is switched off.
- » Activation takes approximately 30 seconds to complete.
- » Turn indicators flash twice.
- » Confirmation tone sounds twice (if programmed).
- » Anti-theft alarm is active.

- with central locking system^{OE} or
- with Keyless Ride^{OE}

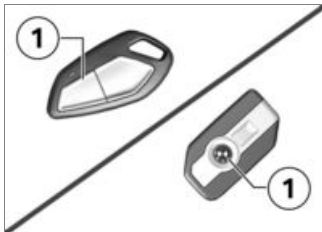

- Switch off the ignition.
- Press button **1** of the remote control or radio-operated key twice.

NOTICE

See also the other functions of the remote control for the central locking system. ◀

- » Activation takes 30 seconds to complete.
- » Turn indicators flash twice.

- » Confirmation tone sounds twice (if programmed).
- » Anti-theft alarm is active.

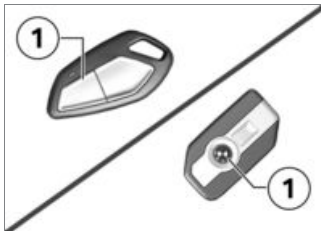

- To deactivate the motion sensor (e.g. to transport the motorcycle by train when the severe movements may activate the alarm), press button **1** of the remote control or radio-operated key again during the activation phase.
- » Turn indicators flash three times.
- » Confirmation tone sounds three times (if programmed).

- » Motion sensor has been deactivated.

Fuses

Replace fuses

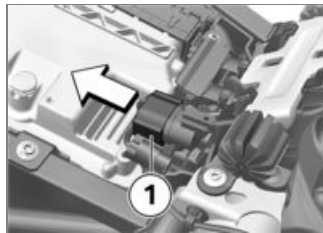

- Switch off the ignition.
- Removing front seat (▶▶ 100).
- Pull off connector **1**.

ATTENTION

Jumpering of blown fuses

Risk of short-circuit and fire

- Never attempt to jumper a blown fuse.

- Always replace a defective fuse with a new fuse of the same amperage.◀
- Replace faulty fuse in accordance with layout plan.



NOTICE

If fuse defects recur frequently have the electric circuits checked by a specialist workshop, preferably an authorised BMW Motorrad dealer.◀

- Install plug **1**.
- Installing front seat (➡ 100).

Fuse assignment

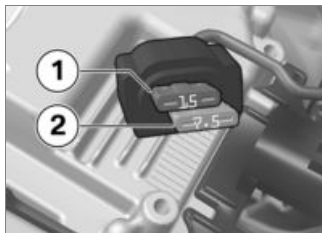

Fuse box

15 A (Slot 1: Instrument cluster, alarm system (DWA), ignition lock, diagnostic socket, topcase light)

7.5 A (Slot 2: Multifunction switch left, tyre pressure control (RDC), audio system)

– with single seat with radio transceiver box^{OE}



Fuse box

15 A (Slot 1: instrument cluster, alarm system (DWA), ignition lock, diagnostic socket, release of the two-way radio box)

7.5 A (Slot 2: Multifunction switch left, tyre pressure control (RDC), audio system)◀



Fuse box

– with US authority^{OE}

15 A (Two-way radio)◀

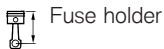
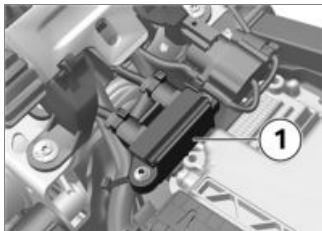

Fuse holder

50 A (Fuse 1: Voltage regulator)

Motorcycle experiences malfunctions

- Only have the diagnostic connector loosened by a specialist workshop or other authorised persons during your next BMW Service appointment.
- Have the work performed by appropriately trained staff.
- Refer to the vehicle manufacturer specifications. ◀
- Removing battery cover (▶▶ 179).

Diagnostic connector

Disengaging diagnostic connector

CAUTION

Incorrect procedure followed when loosening the diagnostic connector for the on-board diagnosis



- Press the hook **1** and pull out the diagnostic connector **2** towards the top.

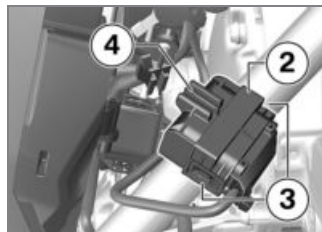

- Press the locks **3** on both sides.

- Loosen the diagnostic connector **2** from the bracket **4**.
» The interface to the diagnosis and information system can be connected to diagnostic connector **2**.

Securing the diagnostic connector

- Disconnect the interface for the diagnosis and information system.

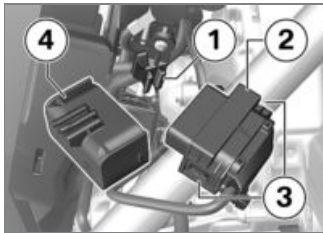

- Insert the diagnostic connector **2** into the bracket **4**.
» The locks **3** engage on both sides.

- Connect the bracket **4** to the mounting **1**.



- Make sure the hook **5** engages.
- Installing the battery cover (→ 181).

Accessories

General instructions.....	190
Power sockets	190
Cases.....	191
Case for special vehicle	193
Fire extinguisher	194
Radio transceiver box	195
Topcase	196
Navigation system	199
Socket for optional accessories	202

General instructions

CAUTION

Use of other-make products

Safety risk

- BMW Motorrad cannot examine or test each product of outside origin to ensure that it can be used on or in connection with BMW vehicles without constituting a safety hazard. Country-specific official authorisation does not suffice as assurance. Tests conducted by these instances cannot make provision for all operating conditions experienced by BMW vehicles and, consequently, they are not sufficient in some circumstances.
- Use only parts and accessories approved by BMW for your vehicle. ◀

BMW has conducted extensive testing of the parts and ac-

cessory products to establish that they are safe, functional and suitable. Consequently, BMW accepts product liability. BMW accepts no liability whatsoever for parts and accessories that it has not approved.

Whenever you are planning modifications, comply with all the legal requirements. Make sure that the vehicle does not infringe the national road-vehicle construction and use regulations applicable in your country.

Your BMW Motorrad dealer can offer expert advice on the choice of genuine BMW parts, accessories and other products. To find out more about accessories go to:

[bmw-motorrad.com/authorities](https://www.bmw-motorrad.com/en-EN/authorities)

[bmw-motorrad.com/authorities](https://www.bmw-motorrad.com/en-EN/authorities)

[bmw-motorrad.com/en-EN/motorcycles](https://www.bmw-motorrad.com/en-EN/motorcycles)

<https://www.bmw-motorrad.com/en-EN/accessories>

[bmw-motorrad.com/en-EN/experience/27/downloads](https://www.bmw-motorrad.com/en-EN/experience/27/downloads)

Power sockets

Connection of electrical devices

- You can start using electrical devices connected to the motorcycle's sockets only when the ignition is switched on.

Cable routing

- The cables from the power sockets to the auxiliary devices must be routed in such a way

that they do not impede the rider.

- The cable routing should not restrict the steering angle or obstruct handling.
- The cables must not be trapped.

Automatic shutdown

- The sockets will be automatically switched off during the start procedure.
- The power supply to the sockets is switched off a certain time after the ignition is switched off, in order to prevent overloading of the on-board electrics. Low-wattage electrical accessories might not be recognised by the vehicle's electronics. In such cases, power sockets are switched off very shortly after the ignition is turned off.

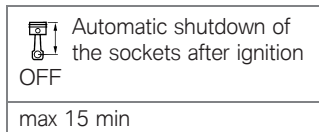

- If the battery charge state is too low to maintain the motorcycle's start capability, the power sockets are switched off.
- The power sockets are also switched off when the maximum load capability as stated in the technical data is exceeded.

Cases

Open cases

- with central locking system^{OE}
- If applicable, open the central locking.◁



- Turn the key to the in the case lock to the position indicated by the dot.

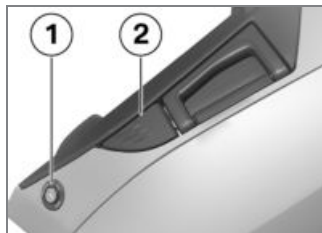

- Push lock barrel **1** down.
» Lever **2** pops up.

- Pull the release lever all the way up and open the lid of the case.

Closing cases



- Pull release lever **2** all the way up.
- Close the lid of the case and press it down. Check that nothing is trapped between the lid and the case.



NOTICE

The cases can also be locked by turning the lock to the LOCK position. In this case, ensure that

the vehicle key is not left in the cases. ◀

- Push release lever **2** down until it engages.
- Turn the key in the case lock to the LOCK position and remove the key from the lock.

Removing cases



- Turn the key to the RELEASE position in the case lock.
- » The handle pops out.



- Pull carry handle **3** up as far as it will go.
- » The case is released and can be removed.

Install cases

- Pull the handle up as far as it will go.



- Seat the case in holders **4**.



- Push handle **3** down until it engages.
- Turn the key in the case lock to the LOCK position and remove the key from the lock.

Maximum payload and maximum permissible speed

Note the maximum permissible payload and the speed limit for riding with cases fitted, as stated on the label inside the case. Contact your authorised BMW Motorrad dealer if you cannot find your combination of vehicle and cases on the label. The values for the combination described here are as follows:

	Maximum speed for riding with a loaded case
	max 180 km/h
	Payload per case
	max 10 kg

Case for special vehicle

– with painted case with holder for special vehicle^{OE}

Open cases

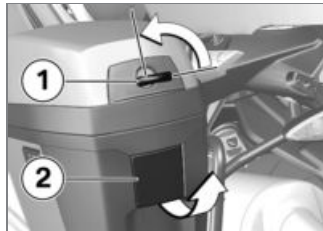

- Open the case lock **1** using the ignition key (**arrow**).
- Pull the lock **2** towards the rear (**arrow**).
- » The case lid is unlocked, but it does not pop open by itself.
- Open the lid.

Closing cases

- Close the case lid and press it shut until the latch engages.

Check that nothing is trapped between the lid and the case.

Fire extinguisher

– with fire extinguisher with holder^{OE}

Removing fire extinguisher

Requirement

The fire extinguisher is located in the left case.

- with painted case with holder for special vehicle^{OE}
- Open cases (▣→ 193).◁

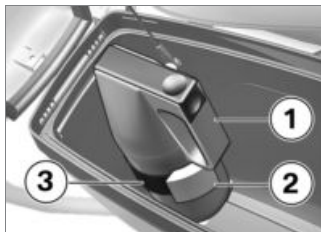

- Hold the fire extinguisher at the carry handle **1** and open closure **2** to release the retaining strap **3**.
- Remove fire extinguisher.

Install fire extinguisher

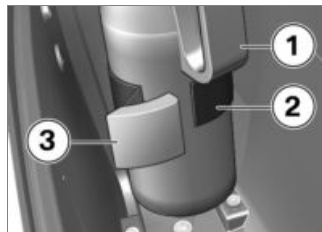

- Hold the fire extinguisher at the carry handle **1** and fit retaining strap **2**. Ensure that the fire extinguisher sits on the storage tray.
- Fit the right-hand side of the closure **3** to the retaining strap **2** and snap shut closure **3**.

Radio transceiver box

Open radio transceiver box

- with single seat with radio transceiver box^{OE}

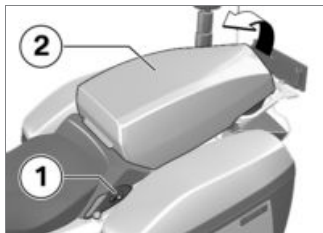

- Press button **1**.
 - » The radio transceiver box is unlocked.
 - » If electrical unlocking has failed, consult the troubleshooting chart in the "Technical data" section. (➡ 212)
- Open lid **2** of the radio transceiver box.

NOTICE

The electrical unlocking has an after-running period the ignition is switched off.

In the default setting, the radio transceiver box can be opened up to 40 seconds after the ignition has been switched off.

Your authorised BMW Motorrad Retailer can encode the after-running period to different values (0, 20, 40 or 60 seconds).◀

Emergency unlocking of radio transceiver box

- with single seat with radio transceiver box^{OE}

Requirement

The radio transceiver box can be unlocked manually if electrical unlocking has failed.

- Switch off the ignition.

- Removing front seat (➡ 100).



- Remove the bolts **1**.

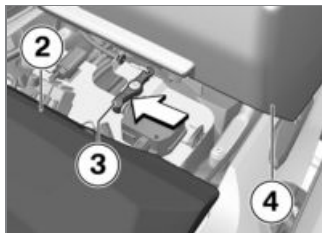

- Pull seat wedge **2** forwards until it is possible to access lever **3**.

- Push lever **3** to the side (**arrow**).
- Open lid **4**.

Closing radio transceiver box

- Close the lid and press it shut until the latch engages. Check that nothing is trapped between the lid and the case.

Topcase

Opening topcase

– with topcase^{OA}

– with central locking system^{OE}

- If applicable, open the central locking.◀



- Turn the key to the in the topcase lock to the position indicated by the dot.

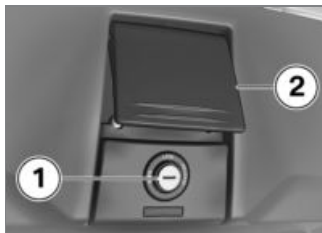

- Push lock barrel **1** forward.
» Lever **2** pops up.

- Pull the release lever all the way up and open the lid of the topcase.

Closing topcase

– with topcase^{OA}



- Pull release lever **2** all the way up.
- Close the lid of the topcase and hold it down. Check that nothing is trapped between the lid and the case.



NOTICE

The topcase can also be locked by turning the lock to the LOCK

position. In this case, make sure that the key is not left inside the topcase.◀

- Push release lever **2** down until it engages.
- Turn the key in the topcase lock to the LOCK position and remove the key from the lock.

Removing the topcase

- Removing front seat (➡ 100).
- Removing rear seat (➡ 101).
- with topcase^{OA}



- Disconnect plug **1**.
- Work the plug of the topcase through to the rear.

- Open the topcase.
- If applicable, empty the topcase and lift out the bottom mat.



- Push slide latch **2** toward the outside and hold it in this position.
- Turn rotary latch **3** in the direction indicated by the RELEASE arrow.
- » Release warning **4** is visible.
- Close the topcase.



- Lift the topcase at the rear and remove it from the luggage carrier.◀
- Install the rear seat (➡ 102).
- Installing front seat (➡ 100).

Installing topcase

- Removing front seat (➡ 100).
- Removing rear seat (➡ 101).
- with topcase^{OA}
- If applicable, empty the topcase and lift out the bottom mat.



- Set the topcase on the luggage carrier.
- Opening topcase (➡ 196).



- Turn rotary latch **3** as far as it will go in the direction indicated by the LOCK arrow

while pressing down on the back edge of the topcase.
 » Release warning **4** is no longer visible.

If the release warning is still visible the topcase is not correctly secured.

- Make sure that the topcase is correctly seated on the luggage carrier.

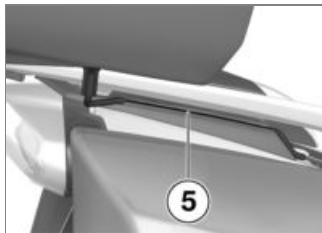

- Route the connecting cable forward in cable guide **5**.

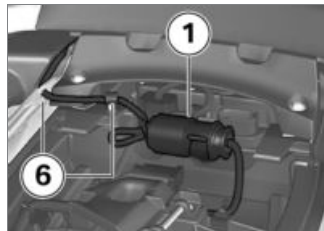

- Work the cable into position at positions **6**.
- Connect plug **1**.<
- Install the rear seat (➡ 102).
- Installing front seat (➡ 100).



Maximum payload and maximum permissible speed

Note the maximum permissible payload and the speed limit for riding with topcase fitted, as stated on the label inside the topcase.

Contact your authorised BMW Motorrad dealer if you cannot

find your combination of vehicle and topcase on the label.

The values for the combination described here are as follows:

 Maximum speed for riding with a loaded topcase
max 180 km/h
 Payload of topcase
max 5 kg

Navigation system

Securing navigation device safely.

- with navigation system^{OA}
- with preparation for navigation system^{OE}



ATTENTION

Dust and dirt on the Mount Cradle contacts

Damaged contacts

- Always reinstall the cover as soon as you finish your ride.◀



NOTICE

The latching system of the Mount Cradle is not designed to protect against theft. Always remove the navigation system and stow it away safely as soon as you finish your ride.◀



- Operate lock **1** and remove cover **2**.



- First insert navigation device **1** in the fixture and then pivot **2** towards the rear.

- Press the navigation device on the upper edge until it engages into place.



- Check that the navigation device is seated firmly in the holder. The cap **1** must be engaged completely. The closing mechanism must be mounted flat and should no longer be visible.

Removing navigation device

- with navigation system^{OA}
- with preparation for navigation system^{OE}



- Operate lock **1** and remove the navigation device **2**.

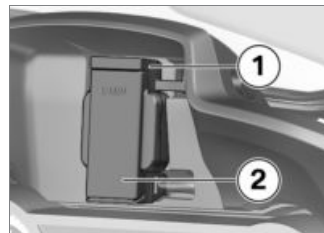

- Install cover **2**.
- Check that the cover is seated firmly in the holder. The upper retaining cap **1** must be completely engaged.

Operating navigation system

- with preparation for navigation system^{OE}
- If applicable, switch on the ignition.
- Call up the Navigation menu.

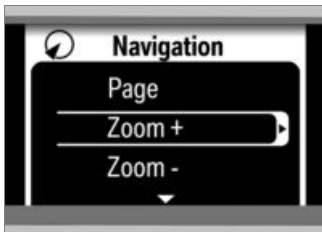

The options for using the navigation system appear on the display.

- **View:** switches between the main menu, map and on-board computer views.
- **Zoom +:** carries out functions labelled with a + in the navigation system. In the map view, for instance, the view zooms in on the map detail.
- **Zoom -:** carries out functions labelled with a - in the navigation system. In the map view, for instance, the view zooms out from the map detail.

- **Voice output:** repeats the last navigation command. The announcement is spoken again even if automatic spoken announcement have been switched off in the settings of the navigation system.
- **Mute:** switches automatic voice output off and on.
- **Display off:** switches the navigation system display on and off.
 - Select the desired operation and carry it out by pressing the Multi-Controller towards the right.

Special functions

- with preparation for navigation system^{OE}

Integration of the BMW Motorrad Navigator V can result in deviations from the descriptions in the operating instructions for the Navigator.

Reserve fuel level warning

The settings for the fuel gauge enable you to define a distance that is covered per full tank of fuel. The motorcycle sends the figure for residual range possible with the fuel remaining in the fuel tank to the Navigator, so it is no longer necessary to enter this value.

Time and date

The Navigator sends time and date to the motorcycle. The transfer of these data into the instrument cluster must be activated in the **SETUP** menu of the instrument cluster.

Security settings

The BMW Motorrad Navigator V can be secured against unauthorised use with a four-digit PIN (Garmin Lock). If this function is activated, while the Navigator is cradled on the motorcycle and

the ignition is switched on you are prompted to add the motorcycle to the list of secured vehicles. If you answer "Yes" at this prompt the Navigator saves the VIN of this vehicle in its internal memory.

A maximum of five VINs can be saved in this way.

Subsequently, the PIN does not have to be entered when the Navigator is switched on by ignition ON while cradled in any of these vehicles.

If the Navigator is removed from the vehicle while switched on, a security prompt asking for the PIN to be entered is issued.

Socket for optional accessories

Example

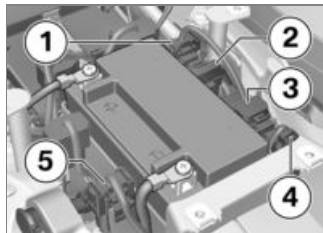

Depending on the selected equipment specification, both sides of the auxiliary battery feature connectors for OE and authority equipment scopes.

Important connectors for OA:

- LED rotating light **1** in blue or red and blue/yellow
- STOP signal **2**
- Authority equipment scope **3**, special output for various functions including speed signal

- Rear fog light **4**
- LED 360° marker strobe **5** in blue or red and blue/yellow



NOTICE

Ask your BMW Motorrad Partner for advice regarding the special function configuration options.

For further information see:

www.bmw-motorrad-authorities.com

www.bmw-motorrad-authorities.com/en-EN/motorcycles

<https://www.bmw-motorrad-authorities.com/en-EN/accessories>

www.bmw-motorrad-authorities.com/en-EN/experience/27/downloads ◀



ATTENTION

Discharging the auxiliary battery as a result of directly connected consumers

Battery is deep-discharged; this voids the guarantee

- Connect additional equipment to the connectors for OA only.◀

Care

Care products	206
Washing the vehicle	206
Cleaning easily damaged components.....	207
Care of paintwork	208
Vehicle preservation	208
Laying up the motorcycle	208
Restoring motorcycle to use	209

Care products

BMW Motorrad recommends that you use the cleaning and care products you can obtain from your authorised BMW Motorrad dealer.

The substances in BMW CareProducts have been tested in laboratories and in practice; they provide optimised care and protection for the materials used in your vehicle.



ATTENTION

Use of unsuitable cleaning and care products

Damage to vehicle parts

- Do not use solvents such as cellulose thinners, cold cleaners, fuel or the like, and do not use cleaning products that contain alcohol. ◀

Washing the vehicle

BMW Motorrad recommends that you use BMW insect remover to soften and wash off insects and stubborn dirt on painted parts prior to washing the vehicle.

To prevent stains, do not wash the vehicle immediately after it has been exposed to strong sunlight and do not wash it in the sun.

Make sure that the vehicle is washed frequently, especially during the winter months.

To remove road salt, clean the motorcycle with cold water immediately after every trip.



WARNING

Wet brake discs and brake pads after vehicle wash, after riding through water and in rainy conditions

Diminished braking effect, risk of accident

- Apply the brakes in good time to allow the friction and heat to dry the brake discs and brake pads. ◀



ATTENTION

Effect of road salt intensified by warm water

Corrosion

- Use only cold water to wash off road salt. ◀



ATTENTION

Damage due to high water pressure from high pressure cleaners or steam cleaners

Corrosion or short circuit, damage to labels, seals, hydraulic brake system, electrical system and the motorcycle seat

- Exercise restraint when using a steam jet or high pressure cleaning equipment.◀

Cleaning easily damaged components

Plastics



Use of unsuitable cleaning agents

Damage to plastic surfaces

- Do not use cleaning agents that contain alcohol, solvents or abrasives.
- Do not use insect-remover pads or cleaning pads with hard, scouring surfaces.◀

Body panels

Clean trim panel components with water and BMW Motorrad solvent cleaner.

Plastic windscreens and headlight lenses

Remove dirt and insects with a soft sponge and generous amounts of water.



Soften stubborn dirt and insects by covering the affected areas with a wet cloth.◀



Clean with water and sponge only.



Do not use any chemical cleaning agents.

Chrome

Carefully clean chrome sections with a generous amount of water and motorcycle cleaner from the care series BMW Motorrad Care Products. This applies especially where road salt has been in use.

For an additional treatment, use BMW Motorrad metal polish.

Radiator

Clean the radiator regularly to prevent overheating of the engine due to inadequate cooling. For example, use a garden hose with low water pressure.



Bending of radiator fins

Damage to radiator fins

- Take care not to bend the radiator fins when cleaning.◀

Rubber components

Treat rubber components with water or BMW rubber-care products.



Application of silicone sprays to rubber seals

Damage to the rubber seals

- Do not use silicone sprays or care products that contain silicon.◀

Care of paintwork

The long-term effects of materials that are damaging to paint can be prevented by regular vehicle washes, particularly if your vehicle is ridden in areas susceptible to high levels of air pollution or natural contamination, for example tree resin or pollen. Particularly aggressive materials, however, should be removed immediately, otherwise changes to or discolouration of the paint can result. These include, for example, spilled fuel, oil, grease, brake fluid or bird excrement. For this, we recommend BMW Motorrad solvent cleaner followed by BMW Motorrad gloss polish for preservation. Contamination of the paint surface can be seen particularly

clearly after a vehicle wash. These areas should be cleaned immediately using benzine or spirit, applied with a clean cloth or cotton pad. BMW Motorrad recommends that tar spots be removed using BMW tar remover. The paint should then be preserved in these areas.

Vehicle preservation

If water no longer rolls off the paint, the paint must be preserved.

For paint preservation, BMW Motorrad recommends the use of BMW Motorrad gloss polish or agents containing carnauba wax or synthetic wax.

Laying up the motorcycle

- Clean the motorcycle.
- Fill the motorcycle's fuel tank with fuel.
- Removing battery (▶▶▶ 179).
- Removing auxiliary battery (▶▶▶ 181).
- Spray the brake and clutch lever pivots and the main and side stand pivots with a suitable lubricant.
- Coat bright metal and chrome-plated parts with an acid-free grease (e.g. Vaseline).
- Stand the motorcycle in a dry room in such a way that there is no load on either wheel (preferably using the front-wheel and rear-wheel stands from BMW Motorrad).

Restoring motorcycle to use

- Remove the protective wax coating.
- Clean the motorcycle.
- Installing battery (▶▶▶ 180).
- Installing auxiliary battery (▶▶▶ 183).
- Comply with checklist (▶▶▶ 120).

Technical data

Troubleshooting chart	212	Weights.....	227
Screw connections	213	Riding specifications	227
Fuel.....	215	Country relevant encoding for sound signals	227
Engine oil	216	Function key assignment	228
Engine	216	Special functions	229
Clutch	217		
Transmission	218		
Rear-wheel drive	219		
Frame	219		
Chassis and suspension	220		
Brakes	221		
Wheels and tyres	222		
Electrical system.....	224		
Anti-theft alarm	226		
Dimensions	226		

Troubleshooting chart

Special functions or OE for authorities are not operational or only available during the journey.

Possible cause

Rectification

The plug connection for the auxiliary battery has been disconnected.

Connect the bridge to the isolation connector (▣▣▣▣ 55)

The engine does not start.

Possible cause

Rectification

Side stand extended and gear engaged

Retract the side stand.

Gear engaged and clutch not disengaged

Select neutral or pull the clutch lever.

No fuel in tank

Refuelling (▣▣▣▣ 130).

Battery flat

Charge battery when connected (▣▣▣▣ 178).

Overheating protection for starter motor has been activated. Starter motor can only be operated for a limited period of time.





Allow the starter motor to cool down for approx. 1 minute before using it again.

Screw connections

Front wheel	Value	Valid
Radial brake caliper on telescopic forks		
M10 x 65	38 Nm	
Bottom fork bridge to slider tube		
M8 x 35	19 Nm	
Wheel-speed sensor to fork leg		
M6 x 16 Micro-encapsulated or medium-strength thread-locking compound	8 Nm	
Quick-release axle in telescopic forks		
M12 x 20	30 Nm	
Rear wheel	Value	Valid
Rear wheel to wheel flange		
M10 x 1.25 x 40	Tightening sequence: tighten in diagonally opposite sequence	
	60 Nm	

Exhaust system	Value	Valid
Silencer to rear frame		
M8 x 35	19 Nm	
Clamp, manifold-rear silencer		
	28 Nm	
Mirror arm	Value	Valid
Mirror to holder		
M6 x 50	8 Nm	

Fuel

Recommended fuel grade	 Super unleaded (maximum 15 % ethanol, E15)  95 ROZ/RON 90 AKI
Alternative fuel grade	 Normal unleaded (power- and consumption-related restrictions.) (max 15 % ethanol, E10/E15)  91 ROZ/RON 87 AKI
Usable fuel capacity	approx. 25 l
Reserve fuel	approx. 4 l
Exhaust emissions standard	Euro 4

Engine oil

Engine oil, capacity	max 4 l, with filter change
Specification	SAE 5W-40, API SL / JASO MA2, Additives (e.g. molybdenum-based) are not permissible because they can attack coated components of the engine, BMW Motorrad recommends BMW Motorrad ADVANTEC Ultimate oil.
Engine oil, quantity for topping up	max 0.8 l, Difference between MIN and MAX

BMW recommends **ADVANTEC**
ORIGINAL BMW ENGINE OIL

Engine

Location of engine number	Crankcase, bottom right, below starter motor
Engine type	A74B12M
Engine design	Air/liquid-cooled, two-cylinder four-stroke opposed-twin engine with two overlying, spur-gear-driven camshafts, a counterbalance shaft and BMW ShiftCam variable intake camshaft control
Displacement	1254 cm ³
Cylinder bore	102.5 mm
Piston stroke	76 mm

Compression ratio	12.5:1
Nominal output	100 kW, at engine speed: 7750 min ⁻¹
– with power reduction ^{OE}	79 kW, at engine speed: 7750 min ⁻¹
Torque	143 Nm, at engine speed: 6250 min ⁻¹
– with power reduction ^{OE}	140 Nm, at engine speed: 5000 min ⁻¹
Maximum engine speed	max 9000 min ⁻¹
Idle speed	1050 min ⁻¹ , Engine at regular operating temperature

Clutch

Clutch type	Multiplate oil-bath clutch, anti-hopping
-------------	--

Transmission

Gearbox type	Claw-shift 6-speed transmission with helical-cut splines
Gearbox transmission ratios	1.000 (60:60 teeth), Primary transmission ratio 1.650 (33:20 teeth), Transmission input ratio 2.438 (39:16 teeth), 1st gear 1.714 (36:21 teeth), 2nd gear 1.296 (35:27 teeth), 3rd gear 1.059 (36:34 teeth), 4th gear 0.943 (33:35 teeth), 5th gear 0.848 (28:33 teeth), 6th gear 1.061 (35:33 teeth), Transmission output ratio

Rear-wheel drive

Type of final drive	Shaft drive with bevel gears
Type of rear suspension	Cast aluminium single swinging arm featuring BMW Motorrad Paralever
Gear ratio of final drive	2.75 (33/12 teeth)
– with alternative ratio ^{OE}	2.82 (31/11 teeth)

Frame

Frame type	Tubular steel frame with supporting drive unit, steel pipe rear frames
Type plate location	Frame, front left at steering head
Position of the Vehicle Identification Number	Frame, front right, on steering head

Chassis and suspension

Front wheel

Type of front suspension	BMW Telelever, with anti-dive top fork bridge, leading link mounted on engine and telescopic forks, central spring strut supported by leading link and frame
Design of front wheel suspension	Central shock absorber with helical spring
– with Dynamic ESA ^{OE}	Central shock absorber complete with torsion spring and header tank, electrically adjustable decompression and compression-stage damping
Spring travel, front	120 mm, at wheel

Rear wheel

Type of rear suspension	Cast aluminium single swinging arm featuring BMW Motorrad Paralever
Type of rear suspension	Central spring strut with coil spring, adjustable rebound-stage damping and spring preload
– with Dynamic ESA ^{OE}	ESA-2 with spring rate adjustment
Spring travel at rear wheel	136 mm

Brakes

Front wheel

Type of front brake	Hydraulically operated twin disc brake with 4-piston radial brake calipers and floating brake discs
Brake-pad material, front	Sintered metal
Brake disc thickness, front	min 4 mm, Wear limit
Play of brake controls (Front brake)	approx. 1.85 mm, at piston

Rear wheel

Type of rear brake	Hydraulically actuated disc brake with 2-piston floating caliper and fixed disc
Brake-pad material, rear	Sintered metal
Brake disc thickness, rear	min 4.5 mm, Wear limit
Blow-by clearance of the footbrake lever	1...1.5 mm, between the frame and the footbrake lever

Wheels and tyres

Recommended tyre sets	Your authorised BMW Motorrad dealer will be happy to supply an up-to-date list of the approved wheel/tyre combinations, or you can check the information posted on the bmw-motorrad.com website.
Speed category, front/rear tyres	W, required at least: 270 km/h
Front wheel	
Front wheel type	Aluminium cast wheel
Front wheel rim size	3.5" x 17"
Tyre designation, front	120/70 - ZR17
Load index, front tyre	min. 58
Permissible wheel load, front	max 210 kg
Permissible front-wheel imbalance	max 5 g

Rear wheel

Rear-wheel type	Aluminium cast wheel
Rear wheel rim size	5.5" x 17"
Tyre designation, rear	180/55 - ZR17
Load index, rear tyre	min. 73
Permissible wheel load, rear	max 330 kg
Permissible rear-wheel imbalance	max 45 g

Tyre pressures

Tyre pressure, front	2.5 bar, tyre cold
Tyre pressure, rear	2.9 bar, tyre cold

Electrical system

Electrical rating of on-board sockets	max 10 A, Total for all sockets
Fuse box	15 A, Slot 1: Instrument cluster, alarm system (DWA), ignition lock, diagnostic socket, topcase light 7.5 A, Slot 2: Multifunction switch left, tyre pressure control (RDC), audio system
– with single seat with radio transceiver box ^{OE}	15 A, Slot 1: instrument cluster, alarm system (DWA), ignition lock, diagnostic socket, release of the two-way radio box 7.5 A, Slot 2: Multifunction switch left, tyre pressure control (RDC), audio system
Fuse holder	50 A, Fuse 1: Voltage regulator
Fuse box	
– with US authority ^{OE}	15 A, Two-way radio

Battery

Battery type	AGM (Absorbent Glass Mat) battery
Battery rated voltage	12 V
Battery rated capacity	16 Ah

Second battery

Battery type	AGM (Absorbent Glass Mat) battery
Battery rated voltage	12 V
Rated capacity of auxiliary battery	
– with auxiliary battery ^{OE}	16 Ah

Spark plugs

Spark plugs, manufacturer and designation	NGK LMAR8AI-10
---	----------------

Lighting

Bulb for high-beam headlight	H1 / 12 V / 55 W
Bulbs for the low-beam headlight	H7 / 12 V / 55 W
Bulb for parking light	LED ring light
Bulb for tail light/brake light	LED
Bulbs for flashing turn indicators, front	LED
Bulbs for flashing turn indicators, rear	LED

Anti-theft alarm

Activation time on arming	approx. 30 s
Alarm duration	approx. 26 s
Battery type	CR 123 A

Dimensions

Length of motorcycle	2222 mm, over number-plate carrier
Height of motorcycle	1405...1570 mm, over windscreen at DIN unladen weight
Width of motorcycle	985 mm, with mirrors 990 mm, with cases
Front-seat height	805...825 mm, Without rider at unladen weight
– with rider's seat, low ^{OE}	760...780 mm, Without rider at unladen weight
– with rider's seat, high ^{OE}	830...850 mm, Without rider at unladen weight
Rider's inside-leg arc, heel to heel	1810...1850 mm, Without rider at unladen weight
– with rider's seat, low ^{OE}	1740...1780 mm, Without rider at unladen weight
– with rider's seat, high ^{OE}	1875...1915 mm, Without rider at unladen weight

Weights

Vehicle kerb weight	279 kg, DIN unladen weight, ready for road, 90 % load of fuel, without optional extras
Permissible gross weight	505 kg
Maximum payload	226 kg

Riding specifications

Top speed	>200 km/h
-----------	-----------

Country relevant encoding for sound signals

Code 0	Germany, DIN
Code 1	France, police
Code 2	France, gendarmerie
Code 3	Netherlands, 2-tone
Code 4	Italy, police
Code 5	Austria, police
Code 7	Sweden
Code 8	ECE siren (HiLo)
Code 9	US siren (airhorn)

Code A	US siren (one-button operation)
Code B	California siren (one-button operation)

Function key assignment

Special functions	Special functions can be assigned to function buttons F1 to F4, depending on equipment fitted and customer request. Consult a specialist workshop, preferably an authorised BMW Motorrad dealer, to have changes made to the coding.
	Marker light + sound signal
	Two-way radio PTT1
	Two-way radio PTT2
	Two-way radio PTT3
	Cruising Light
	Saving road speed
	Special output
	No function
Switch function	Button, push to activate
	Switch, latching

Pushbutton function assignment ex-works	
– with cruising light ^{OE}	F2 = Cruising Light
– with radio preparation ^{OE}	F1 = Two-way radio PTT1, push to activate
	F2 = two-way radio PTT2, push to activate
	F3 = two-way radio PTT3, push to activate
– with km/h instrument cluster for special vehicle ^{OE}	F4 = Save road speed, push to activate

Special functions

Codable special functions	The following special functions can be coded, depending on equipment fitted and customer request. Consult a specialist workshop, preferably an authorised BMW Motorrad dealer, to have changes made to the coding.
	Alternating front lights
	Flash pattern
	Flash sequence
	Marker lights, circuits

Service

BMW Motorrad Service	232
BMW Motorrad Service history	232
BMW Motorrad Mobility services	233
Maintenance work	233
BMW Service	233
Maintenance schedule	237
Maintenance confirmations	238
Service confirmations	252

BMW Motorrad Service

BMW Motorrad has an extensive network of dealerships in place to look after you and your motorcycle in more than 100 countries. Authorised BMW Motorrad dealerships have the technical information and the technical know-how to reliably carry out all maintenance and repair work on your BMW.

You can locate your nearest authorised BMW Motorrad dealership by visiting our website:

bmw-motorrad.com



WARNING

Maintenance and repair work not in compliance with correct procedure

Risk of accident due to consequential damage

- BMW Motorrad recommends having work of this nature carried out on the vehicle by a

specialist workshop, preferably an authorised BMW Motorrad dealer. ◀

In order to help ensure that your BMW is always in optimum condition, BMW Motorrad recommends compliance with the maintenance intervals specified for your motorcycle. Have all maintenance and repair work that is carried out confirmed in the "Service" chapter in this manual. For generous treatment of claims submitted after the warranty period has expired, evidence of regular maintenance is essential.

Your authorised BMW Motorrad dealer can provide information on BMW services and the work undertaken as part of each service.

BMW Motorrad Service history

Entries

Maintenance work that has been carried out is entered in the proof of maintenance. The entries are like a Service Booklet and provide proof of regular maintenance.

If an entry is made in the electronic service booklet of the vehicle, service-relevant data is saved in the central IT systems of BMW AG, Munich.

If there is a change in vehicle owner, the data saved in the electronic service booklet can also be viewed by the new vehicle owner. A BMW Motorrad Retailer or a specialist workshop can also view data that is stored in the electronic service booklet.

Objection

The vehicle owner can object to entries being made by the BMW Motorrad Retailer or a specialist workshop in the electronic service booklet along with the corresponding storage of data in the vehicle and transfer of data to the vehicle manufacturer for the period of time that they are the vehicle owner. In this instance, no entry is made in the electronic service booklet of the vehicle.

BMW Motorrad Mobility services

As owner of a new BMW motorcycle, in circumstances in which assistance is required you can benefit from the protection afforded by the various BMW Motorrad mobility services (e.g. Mobile Service, breakdown service, vehicle recovery service).

Your authorised BMW Motorrad dealer will be happy to provide information about the mobility services available to you.

Maintenance work

BMW Pre-delivery Check

Your authorised BMW Motorrad dealer conducts the BMW pre-delivery check before handing over the vehicle to you.

BMW Running-in Check

The BMW running-in check has to be performed when the vehicle has covered between 500 km and 1200 km.

BMW Service

The BMW Service is carried out once a year. The scope of the service depends on the age of the vehicle and the mileage ridden. Your BMW Motorrad Retailer will confirm the service that

has been carried out for you and will enter the deadline for the next service.

For riders with a high mileage it may be necessary to have a service before the specified deadline. In this case, a corresponding maximum mileage is entered in the service confirmation. If this mileage is reached before the next service deadline, the service must be brought forward.

The service-due indicator in the multifunction display reminds you about one month or 1000 km in advance when the time for a service is approaching, on the basis of the programmed values.

To find out more about service, go to:

bmw-motorrad.com/service

The scope of maintenance work required for your vehicle can be found in the following maintenance schedule:

Maintenance schedule

- 1** BMW running-in check (including oil change)
- 2** BMW Service standard scope
- 3** Engine-oil change, with filter
- 4** Oil change in bevel gears rear
- 5** Check valve clearance
- 6** Replace all spark plugs
- 7** Replace air filter element
- 8** Change brake fluid, entire system
 - a** annually or every 10000 km (whichever comes first)
 - b** every 2 years or every 20000 km (whichever comes first)
 - c** for the first time after one year, then every two years

Maintenance confirmations

BMW Service standard scope

The repair tasks in the BMW Service standard scope are listed below. The actual scope of maintenance work applicable for your vehicle may vary.

- Performing vehicle test with BMW Motorrad diagnostic system
- Visual inspection of clutch system
- Visual inspection of the brake lines, brake hoses and connections
- Check front brake pads and brake discs for wear
- Checking the brake fluid level of the front wheel brake
- Check rear brake pads and brake disc for wear
- Checking brake-fluid level, rear brakes
- Check coolant level
- Check the side stand's ease of movement
- Check the centre stand's ease of movement
- Check tyre pressure and tread depth
- Check lights and signalling system
- Function test, engine start suppression
- Final inspection and check for road safety
- Set service date and remaining distance with BMW Motorrad diagnosis system
- Check state of charge of the battery
- Confirm BMW service in on-board literature

BMW pre-delivery check

carried out

at _____

Stamp, signature

BMW Running-in Check

carried out

at _____

at km _____

Next service

at the latest

at _____

or, when reached earlier

at km _____

Stamp, signature

BMW Service

carried out

at _____

at km _____

Next service

at the latest

at _____

or, when reached earlier

at km _____

Work performed

BMW Service

Yes

No

Oil change, engine, with filter

Oil change in rear bevel gears

Checking valve clearance

Renewing all spark plugs

Renewing air cleaner insert

Checking or replacing air filter element
(for maintenance)

Change brake fluid in entire system

Notes

Stamp, signature

BMW Service

carried out

at _____

at km _____

Next service

at the latest

at _____

or, when reached earlier

at km _____

Stamp, signature

Work performed

BMW Service

Oil change, engine, with filter

Oil change in rear bevel gears

Checking valve clearance

Renewing all spark plugs

Renewing air cleaner insert

Checking or replacing air filter element

(for maintenance)

Change brake fluid in entire system

Yes No

Notes

BMW Service

carried out

at _____

at km _____

Next service

at the latest

at _____

or, when reached earlier

at km _____

Work performed

BMW Service

Yes

No

Oil change, engine, with filter

Oil change in rear bevel gears

Checking valve clearance

Renewing all spark plugs

Renewing air cleaner insert

Checking or replacing air filter element
(for maintenance)

Change brake fluid in entire system

Notes

Stamp, signature

BMW Service

carried out

at _____

at km _____

Next service

at the latest

at _____

or, when reached earlier

at km _____

Stamp, signature

Work performed

BMW Service

Oil change, engine, with filter

Oil change in rear bevel gears

Checking valve clearance

Renewing all spark plugs

Renewing air cleaner insert

Checking or replacing air filter element

(for maintenance)

Change brake fluid in entire system

Yes No

Notes

BMW Service

carried out

at _____

at km _____

Next service

at the latest

at _____

or, when reached earlier

at km _____

Work performed

BMW Service

Yes

No

Oil change, engine, with filter

Oil change in rear bevel gears

Checking valve clearance

Renewing all spark plugs

Renewing air cleaner insert

Checking or replacing air filter element
(for maintenance)

Change brake fluid in entire system

Notes

Stamp, signature

BMW Service

carried out

at _____

at km _____

Next service

at the latest

at _____

or, when reached earlier

at km _____

Stamp, signature

Work performed

BMW Service

Oil change, engine, with filter

Oil change in rear bevel gears

Checking valve clearance

Renewing all spark plugs

Renewing air cleaner insert

Checking or replacing air filter element

(for maintenance)

Change brake fluid in entire system

Yes No

Notes

BMW Service

carried out

at _____

at km _____

Next service

at the latest

at _____

or, when reached earlier

at km _____

Work performed

BMW Service

Yes

No

Oil change, engine, with filter

Oil change in rear bevel gears

Checking valve clearance

Renewing all spark plugs

Renewing air cleaner insert

Checking or replacing air filter element
(for maintenance)

Change brake fluid in entire system

Notes

Stamp, signature

BMW Service

carried out

at _____

at km _____

Next service

at the latest

at _____

or, when reached earlier

at km _____

Stamp, signature

Work performed

BMW Service

Oil change, engine, with filter

Oil change in rear bevel gears

Checking valve clearance

Renewing all spark plugs

Renewing air cleaner insert

Checking or replacing air filter element

(for maintenance)

Change brake fluid in entire system

Yes No

Notes

BMW Service

carried out

at _____

at km _____

Next service

at the latest

at _____

or, when reached earlier

at km _____

Work performed

BMW Service

Yes

No

Oil change, engine, with filter

Oil change in rear bevel gears

Checking valve clearance

Renewing all spark plugs

Renewing air cleaner insert

Checking or replacing air filter element
(for maintenance)

Change brake fluid in entire system

Notes

Stamp, signature

BMW Service

carried out

at _____

at km _____

Next service

at the latest

at _____

or, when reached earlier

at km _____

Stamp, signature

Work performed

BMW Service

Oil change, engine, with filter

Oil change in rear bevel gears

Checking valve clearance

Renewing all spark plugs

Renewing air cleaner insert

Checking or replacing air filter element

(for maintenance)

Change brake fluid in entire system

Yes No

Notes

BMW Service

carried out

at _____

at km _____

Next service

at the latest

at _____

or, when reached earlier

at km _____

Work performed

BMW Service

Yes

No

Oil change, engine, with filter

Oil change in rear bevel gears

Checking valve clearance

Renewing all spark plugs

Renewing air cleaner insert

Checking or replacing air filter element
(for maintenance)

Change brake fluid in entire system

Notes

Stamp, signature

BMW Service

carried out

at _____

at km _____

Next service

at the latest

at _____

or, when reached earlier

at km _____

Stamp, signature

Work performed

BMW Service

Oil change, engine, with filter

Oil change in rear bevel gears

Checking valve clearance

Renewing all spark plugs

Renewing air cleaner insert

Checking or replacing air filter element

(for maintenance)

Change brake fluid in entire system

Yes No

Notes

Appendix

Certificate for electronic immobiliser	256
Certificate for remote key	258
Certificate for Keyless Ride	262
Certificate for tyre pressure control (RDC)	264

FCC Approval

Ring aerial in the ignition switch



To verify the authorization of the ignition key, the electronic immobilizer exchanges information with the ignition key via the ring aerial.

This device complies with Part 15 of the FCC rules. Operation is subject to the following two conditions:

- (1) This device may not cause harmful interference, and
- (2) this device must accept any interference received, including interference that may cause undesired operation.



Any changes or modifications not expressly approved by the party responsible for compliance could void the user's authority to operate the equipment. ◀

Approbation de la FCC

Antenne annulaire présente dans le commutateur d'allumage



Pour vérifier l'autorisation de la clé de contact, le système d'immobilisation électronique échange des

informations avec la clé de contact via l'antenne annulaire.

Le présent dispositif est conforme à la partie 15 des règles de la FCC. Son utilisation est soumise aux deux conditions suivantes :

- (1) Le dispositif ne doit pas produire d'interférences nuisibles, et
- (2) le dispositif doit pouvoir accepter toutes les interférences extérieures, y compris celles qui pourraient provoquer une activation inopportune.



Toute modification qui n'aurait pas été approuvée expressément par l'organisme responsable de l'homologation peut annuler l'autorisation accordée à l'utilisateur pour utiliser le dispositif. ◀

Certifications

Remote Control for central locking system



Česky

Meta System S.p.A. tímto prohlašuje, že tento PF240009 je ve shodě se základními požadavky a dalšími příslušnými ustanoveními směrnice 1999/5/ES.

Dansk

Undertegnede Meta System S.p.A. erklærer herved, at følgende udstyr PF240009 overholder de væsentlige krav og øvrige relevante krav i direktiv 1999/5/EF.

Deutsch

Hiermit erklärt Meta System S.p.A., dass sich das Gerät PF240009 in Übereinstimmung mit den grundlegenden Anforderungen und den übrigen einschlägigen Bestimmungen der Richtlinie 1999/5/EG befindet.

Eesti

Käesolevaga kinnitab Meta System S.p.A. seadme PF240009 vastavust direktiivi 1999/5/EÜ põhinõuetele ja nimetatud direktiivist tulenevatele teistele asjakohastele sätetele.

English

Hereby, Meta System S.p.A., declares that this PF240009 is in compliance with the essential requirements and other relevant provisions of Directive 1999/5/EC.

Español

Por medio de la presente Meta System S.p.A. declara que el PF240009 cumple con los requisitos esenciales y cualesquiera otras disposiciones aplicables o exigibles de la Directiva 1999/5/CE.

Certifications

Ελληνική

ΜΕ ΤΗΝ ΠΑΡΟΥΣΑ Meta System S.p.A. ΔΗΛΩΝΕΙ ΟΤΙ PF240009 ΣΥΜΜΟΡΦΩΝΕΤΑΙ ΠΡΟΣ ΤΙΣ ΟΥΣΙΩΔΕΙΣ ΑΠΑΙΤΗΣΕΙΣ ΚΑΙ ΤΙΣ ΛΟΙΠΕΣ ΣΧΕΤΙΚΕΣ ΔΙΑΤΑΞΕΙΣ ΤΗΣ ΟΔΗΓΙΑΣ 1999/5/ΕΚ.

Français

Par la présente Meta System S.p.A. déclare que l'appareil PF240009 est conforme aux exigences essentielles et aux autres dispositions pertinentes de la directive 1999/5/CE.

Italiano

Con la presente Meta System S.p.A. dichiara che questo PF240009 è conforme ai requisiti essenziali ed alle altre disposizioni pertinenti stabilite dalla direttiva 1999/5/CE.

Latviski

Ar šo Meta System S.p.A. deklarē, ka PF240009 atbilst Direktīvas 1999/5/ΕΚ būtiskajām prasībām un citiem ar to saistītajiem noteikumiem.

Lietuvių

Šiuo Meta System S.p.A. deklaruoja, kad šis PF240009 atitinka esminius reikalavimus ir kitas 1999/5/EB Direktyvos nuostatas.

Nederlands

Hierbij verklaart Meta System S.p.A. dat het toestel PF240009 in overeenstemming is met de essentiële eisen en de andere relevante bepalingen van richtlijn 1999/5/EG.

Malti

Hawnhekk, Meta System S.p.A., jiddikjara li dan PF240009 jikkonforma mal-ħtiġijiet essenzjali u ma provvedimenti oħrajn relevanti li hemm fid-Dirrettiva 1999/5/EC.

Magyar

Alulírott, Meta System S.p.A. nyilatkozom, hogy a PF240009 megfelel a vonatkozó alapvető követelményeknek és az 1999/5/EC irányelv egyéb előírásainak.

Polski

Niniejszym Meta System S.p.A. oświadcza, że PF240009 jest zgodny z zasadniczymi wymogami oraz pozostałymi stosownymi postanowieniami Dyrektywy 1999/5/EC.

Português

Meta System S.p.A. declara que este PF240009 está conforme com os requisitos essenciais e outras disposições da Directiva 1999/5/CE.

Certifications

Slovensko

Meta System S.p.A. izjavlja, da je ta PF240009 v skladu z bistvenimi zahtevami in ostalimi relevantnimi določili direktive 1999/5/ES.

Slovensky

Meta System S.p.A. týmto vyhlasuje, že PF240009 spĺňa základné požiadavky a všetky príslušné ustanovenia Smernice 1999/5/ES.

Suomi

Meta System S.p.A. vakuuttaa täten että PF240009 tyyppinen laite on direktiivin 1999/5/EY oleellisten vaatimusten ja sitä koskevien direktiivin muiden ehtojen mukainen.

Svenska

Härmed intygar Meta System S.p.A. att denna PF240009 står i överensstämmelse med de väsentliga egenskapskrav och övriga relevanta bestämmelser som framgår av direktiv 1999/5/EG.

Íslenska

Hér með lýsir Meta System S.p.A. yfir því að PF240009 er í samræmi við grunnkröfur og aðrar kröfur, sem gerðar eru í tilskipun 1999/5/EC.

Norsk

Meta System S.p.A. erklærer herved at utstyret PF240009 er i samsvar med de grunnleggende krav og øvrige relevante krav i direktiv 1999/5/EF.

USA, Canada

Product name: TX BMW MR FCC ID: P3098400 IC:4429A - TXBMWMR

This device complies with Part 15 of the FCC rules. Operation is subject to the following two conditions:

- (1) This device may not cause harmful interference, and
- (2) this device must accept any interference received, including interference that may cause undesired operation.



Any changes or modifications not expressly approved by the party responsible for compliance could void the user's authority to operate the equipment.

Declaration Of Conformity

R&TTE Declaration Of Conformity (DoC)

CE0470

We:

Meta System S.p.A.

with the address:

Via Majakovskij 10 b/c/d/e
42124 Reggio Emilia -Italy

Declare

Under own responsibility that the product:

TX BMW MR

To which this declaration relates is in conformity with the essential requirements and other relevant requirements of the R&TTE Directive (1999/5/EC).

This product is in conformity with the following standards:

Health & Safety (art.3.1)

EN 60950-1

EMC (art.3.2)

ETSI EN 301 489-1/-3

Spectrum

ETSI EN 300 220 - 2

Human exposure

EN 62311

According to Directive 1999/5/CE

Reggio Emilia , 14/07/2010

Technical Director
Lasagni Cesare



Certifications

BMW Keyless Ride ID Device



USA, Canada

Product name: BMW Keyless Ride ID Device
FCC ID: YGOHUF5750
IC: 4008C-HUF5750

Canada:

Operation is subject to the following two conditions:

- (1) This device may not cause harmful interference, and
- (2) this device must accept any interference received, including interference that may cause undesired operation.

USA:

This device complies with Part 15 of the FCC rules. Operation is subject to the following two conditions:

- (1) This device may not cause harmful interference, and
- (2) this device must accept any interference received, including interference that may cause undesired operation.



Any changes or modifications not expressly approved by the party responsible for compliance could void the user's authority to operate the equipment.

Declaration Of Conformity

We declare under our responsibility that the product

BMW Keyless Ride ID Device (Model: HUF5750)

complies with the appropriate essential requirements of the article 3 of the R&TIE and the other relevant provisions, when used for its intended purpose. Applied Standards:

1. Health and safety requirements contained in article 3 (1) a)
 - EN 60950-1:2006+A11:2009+A1:2010+A12:2011; Information technology equipment- Safety
2. Protection requirements with respect to electromagnetic compatibility article 3 (1) b)
 - EN 301 489-1 (V1.9.2, 09/2011), Electromagnetic compatibility and radio spectrum matters (ERM); Electromagnetic compatibility (EMC) standard for radio equipment and services; Part 1: Common technical requirements
 - EN 301 489-3 (V1.4.1, 08/2002) Electromagnetic compatibility and radio spectrum matters (ERM); Electromagnetic compatibility (EMC) standard for radio equipment and services; Part 3: Specific conditions for short range devices (SRD) operating on frequencies between 9 kHz and 40 GHz
3. Means of the efficient use of the radio frequency spectrum article 3 (2)
 - EN 300 220-1 & -2 (V2.4.1, 05/2012), electromagnetic compatibility and radio spectrum matters (ERM); Short range devices (SRD); Radio equipment to be used in the 25 MHz to 1000 MHz frequency range with power levels ranging up to 500 mW;
Part 1: Technical characteristics and test methods.
Part 2: Harmonized EN covering essential requirements under article 3.2 of the R&TIE directive

The product is labeled with the CE marking: **CE**

Velbert, October 15th, 2013

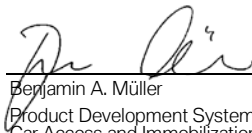

Benjamin A. Müller
Product Development Systems
Car Access and Immobilization – Electronics
Huf Hüsbeck & Fürst GmbH & Co. KG
Steeger Straße 17, D-42551 Velbert

Certification Tire Pressure Control (TPC)

FCC ID: MRXBC54MA4
IC: 2546A-BC54MA4

FCC ID: MRXBC5A4
IC: 2546A-BC5A4

This device complies with Part 15 of the FCC Rules and with Industry Canada license-exempt RSS standard(s).

Operation is subject to the following two conditions:

- (1) This device may not cause harmful interference, and
- (2) This device must accept any interference received, including interference that may cause undesired operation.

Le présent appareil est conforme aux CNR d'Industrie Canada applicables aux appareils radio exempts de licence. L'exploitation est autorisée aux deux conditions suivantes:

- (1) l'appareil ne doit pas produire de brouillage, et
- (2) l'utilisateur de l'appareil doit accepter tout brouillage radioélectrique subi, même si le brouillage est susceptible d'en compromettre le fonctionnement.

WARNING: Changes or modifications not expressly approved by the party responsible for compliance could void the user's authority to operate the equipment. The term "IC:" before the radio certification number only signifies that Industry Canada technical specifications were met.

3

- 360° marker strobe
operate, 71

A

- Abbreviations and symbols, 6

ABS

- Engineering details, 136
- operate, 85
- Self-diagnosis, 122
- Status indicators, 44
- Switching off, 85
- Switching on, 85

Accessories

- General instructions, 190
- Socket for optional accessories, 202

Actuality, 8

Ambient temperature

- Outside temperature
warning, 37
- Reading, 51

Anti-theft alarm

- Indicator light, 23
- operate, 94
- Warning, 40

ASC

- Control, 19
- operate, 85
- Self-diagnosis, 123
- Status indicators, 45

Auxiliary battery

- install, 183
- remove, 181
- Special functions, 55

Auxiliary headlights

- operate, 64

Average values

- reset, 82

B

Battery

- Charging battery when connected, 178
- Charging battery when disconnected, 179
- Indicator light for battery charge voltage, 42
- Installation, 180
- Maintenance instructions, 177
- Removal, 179

Technical data, 224, 225

- Warning for battery voltage low, 41

Brake fluid

- Checking fluid level, front, 158
- Checking fluid level, rear, 159
- Reservoir, front, 17
- Reservoir, rear, 17

Brake pads

- Checking front, 156
- checking rear, 157
- Running in, 124

Brakes

- ABS Pro in detail, 138
- ABS Pro depending on riding mode, 127
- Adjust hand lever, 112
- Checking function, 155
- Safety information, 126
- Technical data, 221

C

Care

- Chrome, 207
- Paintwork preservation, 208

- Cases
 - operate, 191
- Central locking
 - operate, 103
 - Warning for lock status, 48
- Checklist, 120
- Clock
 - Adjusting, 81
- Clutch
 - Adjust hand lever, 112
 - Fluid tank, 15
 - Technical data, 217
- Coolant
 - Checking fill level, 160
 - Fill-level indicator, 17
 - Topping up, 161
 - Warning for overtemperature, 38
- Cruise-control system
 - Control, 19
 - operate, 89
- Cruising light
 - Function, 65
 - operate, 66
- D**
- Date
 - Adjusting, 81
- Daytime riding lights
 - automatic daytime riding light, 67
 - Manual daytime riding light, 66
- Diagnostic connector
 - Loosen, 187
 - secure, 188
- Dimensions
 - Technical data, 226
- DTC, 86
 - Engineering details, 141
 - Indicator light, 45
 - Self-diagnosis, 123
- DWA
 - Technical data, 226
- Dynamic Brake Control, 145
 - Engineering details, 145
- E**
- Electrics
 - Technical data, 224
- Emergency off switch (kill switch), 21
 - Operation, 62
- Emissions warning light, 38
- Engine
 - Indicator light for engine electronics, 39
 - Malfunction indicator lamp, 38
 - starting, 121
 - Technical data, 216
- Engine oil
 - Checking fill level, 154
 - Electronic oil-level check, 50
 - Filler neck, 17
 - Oil level dipstick, 17
 - Technical data, 216
 - Topping up, 155
 - Warning for engine oil level, 38
- Engine run-on circuit
 - Engineering details, 150
 - Switching on and off, 59
- Equipment, 7

ESA
Control, 19
Engineering details, 142
operate, 87

F

Frame
Technical data, 219
Front seat
Adjusting seat height, 101
Height adjustment, 18
install, 100
Installation, 100
Lock, 15
remove, 100
Front-wheel stand
install, 153
Fuel
Filler neck, 15
Fuel grade, 129
Refuelling, 130
refuelling with Keyless
Ride, 131
Technical data, 215

Fuel reserve
Range, 50
Warning, 49
Fuses
Position on the vehicle, 18
Replacing, 185

G

General views
Indicator and warning lights, 26
Instrument panel, 23
Left multifunction switch, 19
Left side of vehicle, 15
Multifunction display, 29
Right multifunction switch, 21
Right side of vehicle, 17
Underneath the seat, 18

H

Hazard warning flashers
Control, 19
operate, 68
Headlight
Headlight beam throw, 110
Headlight courtesy delay
feature, 63

Heated handlebar grips
operate, 98
Hill Start Control, 149
Engineering details, 149
Hill Start Control, 91
Indicator and warning lights, 47
operate, 91
Hill Start Control Pro
cannot be activated, 47
Engineering details, 149
Indicator and warning lights, 47,
48
operate, 92
Horn, 19

I

Ignition
switching off, 55
switching on, 54
Immobiliser
Emergency key, 59
Spare key, 56
Warning, 37

Instrument panel
adjust, 111
Ambient-light brightness
sensor, 23
Overview, 23

J
Jump-start, 176

K
Keyless Ride
Battery of the radio-operated
key is empty, 60
Electronic immobiliser EWS, 59
Fuel filler cap, unlocking, 131
Lock the handlebars, 57
Loss of the radio-operated
key, 60
Switching off ignition, 58
Switching on ignition, 57
Warning, 37, 38
Keys, 54, 56

L
Light signals
Operating the front stop
signal, 72
Operating the rear stop
signal, 73
Lighting
High-beam headlight, 173
LED rear light, replacing, 175
Low-beam headlight, 171
Replacing the LED additional
headlights, 176
Technical data, 225
Warning for bulb failure, 40
Waveguide rings,
replacing, 176
Lights
automatic daytime riding
light, 67
Control, 19
Headlight courtesy delay
feature, 63
Headlight flasher, 63
High-beam headlight, 63
Low-beam headlight, 63

Manual daytime riding light, 66
Parking lights, 63
Side light, 63
Lights-off setting
Operation, 75
Loudspeaker
Microphone, 77
Luggage
Instructions for loading, 118
M
Maintenance
General instructions, 152
Maintenance schedule, 237
Maintenance confirmations, 238
Maintenance intervals, 233
Marker strobe
operate, 69
Mirrors
adjust, 110
Mobility services, 233

Motorcycle
 care, 205
 cleaning, 205
 Lashing, 133
 Laying up, 208
 Parking, 128

Multifunction display, 23
 Control, 19
 Meaning of symbols, 27
 Overview, 29
 Select display, 78
 Settings, 81

Multifunction switch
 General view, left side, 19
 General view, right side, 21

N

Navigation devices
 installing, 199
 operate, 200
 removing, 200

O

Odometer and tripmeters
 operate, 84

Official-user speedometer
 Mode of presentation, 52
 Saving road speed, 83, 84

On-board computer
 operate, 82

P

Parking, 128

Power socket
 Notes on use, 190
 Position on the vehicle, 17

Pre-Ride-Check, 121

R

RDC
 Engineering details, 146
 Reading, 51
 Warnings, 42
 Wheel rim stickers, 164

Rear fog light
 Operation, 68

Rear seat
 install, 101, 102
 remove, 101

Rear-wheel drive
 Technical data, 219

Refuelling, 130
 Fuel grade, 129
 with Keyless Ride, 131

Remote control
 registration, 104
 Replacing battery, 61, 106
 synchronising, 105

Rev. counter, 23

Riding mode
 adjust, 88
 Engineering details, 143

Riding specifications
 Technical data, 227

Running gear
 Technical data, 220

Running in, 124

S

Safety instructions
 for brakes, 126
 For riding, 118

Seat heating
 operate, 98

- Service, 232
 - Service history, 232
 - Warning, 49
- Service-due indicator, 49
- Shift assistant, 125, 147
 - Engineering details, 147
 - Gear not calibrated, 48
 - Riding, 125
- Silencer
 - Pivot silencer outwards, 169
 - Securing silencer, 170
- Siren
 - Operation, 76
- Sound signals
 - Operation, 75
- Spark plugs
 - Technical data, 225
- Speedometer, 23
- Spray guard
 - adjusting, 102
- Spring preload
 - adjust, 113
- Starting, 121
 - Control, 21
- Steering lock
 - Locking, 54
- Stowage compartment
 - operate, 103
 - Position on the vehicle, 15, 17
- Surround lighting
 - switching on, 64
- Symbols
 - Meaning, 27
- T**
- Technical data
 - Anti-theft alarm, 226
 - Battery, 224
 - Brakes, 221
 - Bulbs, 225
 - Chassis and suspension, 220
 - Clutch, 217
 - Dimensions, 226
 - Electrical system, 224
 - Engine, 216
 - Engine oil, 216
 - Frame, 219
 - Fuel, 215
 - General instructions, 7
 - Rear-wheel drive, 219
 - Riding specifications, 227
 - Second battery, 225
 - Spark plugs, 225
 - Standards, 7
 - Transmission, 218
 - Weights, 227
 - Wheels and tyres, 222
- Telltale lights, 23
 - Overview, 26
- Threaded fasteners, 213
- Toolkit
 - Contents, 152
 - Position on the vehicle, 18
- Topcase
 - operate, 196
- Torques, 213
- Traction control
 - ASC, 139
- Transmission
 - Technical data, 218
- Troubleshooting chart, 212
- Turn indicators
 - Control, 19
 - operate, 69

- Two-way radio box
 - Emergency unlocking, 195
 - operate, 195
- Type plate
 - Position on the vehicle, 17
- Tyres
 - Check filling pressure, 162
 - Check tread depth, 162
 - Checking tread depth, 163
 - Pressures, 223
 - Recommendation, 163
 - Running in, 125
 - Technical data, 222
 - Top speed, 119

V

- Vehicle
 - Restoring to use, 209
- Vehicle Identification Number
 - Position on the vehicle, 17

W

- Warning lights, 23
 - Overview, 26

- Warnings
 - ABS, 44
 - Anti-theft alarm, 40
 - ASC, 45
 - Battery charge voltage, 42
 - Bulb defect, 40
 - Central locking, 48
 - Coolant temperature, 38
 - DTC, 45
 - Engine electronics, 39
 - Engine oil level, 38
 - Fuel reserve, 49
 - Gear not calibrated, 48
 - Hill Start Control, 47
 - Hill Start Control , 48
 - Hill Start Control Pro, 47
 - Immobiliser, 37
 - Malfunction indicator lamp, 38
 - Mode of presentation, 30
 - Outside temperature warning, 37
 - RDC, 42
 - Service, 49

- Undervoltage, 41
- Warnings, overview, 31
- Weights
 - Technical data, 227
- Wheels
 - Change of size, 163
 - Check wheel rims, 162
 - Checking rims, 162
 - Installing front wheel, 166
 - Installing the rear wheel, 169
 - Removing front wheel, 164
 - Removing rear wheel, 168
 - Technical data, 222
- Windscreen
 - adjust, 110
 - Control, 19

Details described or illustrated in this booklet may differ from the vehicle's actual specification as purchased, the accessories fitted or the national-market specification. No claims will be entertained as a result of such discrepancies.

Dimensions, weights, fuel consumption and performance data are quoted to the customary tolerances.

The right to modify designs, equipment and accessories is reserved.

Errors and omissions excepted.

© 2018 Bayerische Motoren Werke Aktiengesellschaft
80788 Munich, Germany
Not to be reproduced by any means whatsoever, wholly or in part, without the written permission of BMW Motorrad, After Sales.

Original rider's manual, printed in Germany.

